

HF COMMUNICATIONS RECEIVER

Type CR.150/3

TECHNICAL HANDBOOK

Ref. No. T.2148/1

Marconi

MARCONI'S WIRELESS TELEGRAPH COMPANY LIMITED

Head Office: Marconi House, Chelmsford · Telephone: Chelmsford 3221 · Telegraphic Address: Expanse, Chelmsford

CONTENTS

| SECTION | SUBJECT | PAGE |
|---------|--|-------|
| 1 | LIST OF ILLUSTRATIONS | (iii) |
| 2 | INTRODUCTION | 1 |
| | 2.1 Table of Dimensions and Weights | 1 |
| | 2.2 Valve List | 1 |
| 3 | TECHNICAL SUMMARY | 2 |
| | 3.1 Salient Features | 2 |
| | 3.2 Performance | 3 |
| 4 | GENERAL DESCRIPTION | 5 |
| | 4.1 Controls | 5 |
| | 4.2 Component Locations | 6 |
| | 4.3 External Connections | 6 |
| | 4.4 Mechanical Design | 7 |
| 5 | CIRCUIT DESCRIPTION | 7 |
| | 5.1 General Circuit Arrangement | 7 |
| | 5.2 Signal Frequency Circuits | 7 |
| | 5.3 Intermediate Frequency Circuits | 8 |
| | 5.4 Beat Oscillator and Signal Detector | 8 |
| | 5.5 Audio Frequency Circuits | 8 |
| | 5.6 Automatic Gain Control Circuits | 8 |
| | 5.7 Noise Limiter | 9 |
| | 5.8 Crystal Calibrator | 9 |
| | 5.9 Desensitising Circuit | 9 |
| | 5.10 Diversity Working | 9 |
| | 5.11 Supply Unit | 9 |
| 6 | INSTALLATION | 10 |
| | 6.1 Power Supplies | 10 |
| | 6.2 Aerial Input | 10 |
| | 6.3 Outputs | 10 |
| | 6.4 Automatic Gain Control | 11 |
| | 6.5 Diversity Connections | 11 |
| | 6.6 Desensitising Facilities | 11 |
| 7 | OPERATION | 12 |
| | 7.1 Operating Sequence | 12 |
| | 7.2 Use of Pass Band Switch | 13 |
| | 7.3 Use of AGC | 13 |
| | 7.4 Use of Gain Controls | 13 |
| | 7.5 Use of Calibrator | 13 |
| | 7.6 Use of Signal Indicator and Meter Switch | 13 |
| | 7.7 Use of Logging Scale | 14 |
| | 7.8 Use of Crystal Control | 14 |
| | 7.9 Adjustment of Beat Oscillator | 14 |
| | 7.10 Warming Up | 14 |

| SECTION | SUBJECT | PAGE |
|---------|---|------|
| 8 | MAINTENANCE AND SERVICING | 15 |
| | 8.1 Maintenance | 15 |
| | 8.2 Emergency Servicing | 15 |
| | 8.3 Circuit Checks | 16 |
| | 8.4 Meter Readings | 18 |
| | 8.5 Receiver Alignment Tests | 20 |
| | 8.6 Overall Performance | 25 |
| | 8.7 Supply Unit | 26 |
| 9 | USEFUL AUXILIARY EQUIPMENT | 27 |
| 10 | COMPONENTS AND SPARES | 28 |
| | 10.1 Main Items | 28 |
| | 10.2 Accessories | 28 |
| | 10.3 List No. 1, CR.150/3 Receiver | 29 |
| | 10.4 List No. 2, Supply Unit Type 1325/1, 2 and 3 | 40 |
| | 10.5 List No. 3, Supply Unit Type 1325/4 and 5 | 42 |

LIST OF ILLUSTRATIONS

| FIG. | SUBJECT | PAGE |
|---------------------------|---|------|
| GENERAL | | |
| 1 | Front View | (iv) |
| 2 | Block Diagram | 2 |
| 3 | Terminal and Supply Board | 10 |
| 4 | Front Panel (Control Layout) | 12 |
| 5 | Logging Scale | 14 |
| 6 | Ganging Tool | 21 |
| 7 | Upper Deck Plan | 44 |
| 8 | Lower Deck Plan | 45 |
| 9 | Resistance Boards | 46 |
| 19 | Method of Fixing Aerial Feeder Cable to Plug | 50 |
| 20 | Cord Drive Assembly | 50 |
| 21 | 1st Oscillator Diversity Connections | 50 |
| PERFORMANCE CURVES | | |
| 10 | Audio Frequency Response | 47 |
| 11 | LF Filter Response | 47 |
| 12 | IF Response | 47 |
| 13 | Selectivity Curves | 47 |
| 14 | Overall Frequency Response | 47 |
| 15 | AGC Response | 47 |
| 16 | Frequency Drift | 47 |
| CIRCUIT DIAGRAMS | | |
| 17 | Circuit Diagram of Receiver | 48 |
| 18a | Circuit Diagram of Supply Unit Type 1325/1, 2 and 3 | 49 |
| 18b | Circuit Diagram of Supply Unit Type 1325/4 and 5 | 49 |

APPENDIX I



5329

FIG. 1. MARCONI HF COMMUNICATIONS RECEIVER TYPE CR.150/3. FRONT VIEW.

2. INTRODUCTION

The Marconi CR.150/3 Receiver is a high performance communications receiver for use in the high-frequency band between 2 Mc/s and 60 Mc/s. It is of the double superheterodyne type with first intermediate frequency at 1600 kc/s and second intermediate frequency at 465 kc/s.

This model (see Fig. 1) is a re-designed version of the well-known CR.150, incorporating a number of improvements. These include crystal control of the first oscillator on any one chosen frequency, front of panel control of the aerial trimming condenser, and a desensitising control to enable the receiver to be muted during transmission.

To reduce temperature changes in the receiver the power supply unit is contained in a separate case which can either be placed beside the receiver or stowed in any other convenient position.

2.1 TABLE 1. OVERALL DIMENSIONS AND WEIGHTS

| | Width | Depth | Height | Weight |
|----------------------------|------------------------|--------------------|----------------------|----------------------|
| Receiver Unit | 20.5 in. (52 cm.) | 17 in. (43 cm.) | 14 in. (35.6 cm.) | 61 lb. (28 kg.) |
| Supply Unit Type 1325/1 | 5.25 in. (13.3 cm.) | 15 in. (38 cm.) | 10 in. (25.4 cm.) | 19 lb. (8.6 kg.) |
| Supply Unit Type 1325/4 | 5.25 in. (13.3 cm.) | 15 in. (38 cm.) | 12 in. (30.5 cm.) | 25 lb. (11.3 kg.) |

2.2 TABLE 2. VALVE LIST

| RECEIVER | | | | |
|---------------------------------|--------------|------------|---------------------|---|
| Qty. | Circuit Ref. | Type | Function | Purpose |
| 2 | V1, V2 | EF.50 | Pentode | Signal Frequency Amplifier. |
| 1 | V3 | EF.50 | Pentode | First Frequency Changer. |
| 1 | V4 | EF.50 | Pentode | First Oscillator |
| 1 | V5 | X.66 | Triode-Hexode | Second Oscillator and Frequency Changer. |
| 2 | V6, V7 | 6K7G | Pentode | IF Amplifiers. |
| 1 | V8 | DH.63 | Double-Diode-Triode | Detector, AGC rectifier and AF amplifier. |
| 1 | V9 | 6K7G | Pentode | Beat Oscillator. |
| 1 | V10 | DH.63 | Double-Diode-Triode | Noise Limiter and Calibrating Oscillator. |
| 1 | V11 | L.63 | Triode | LF Output Stage |
| 1 | V12 | STV.280/40 | Stabilivolt | Voltage Stabiliser. |
| SUPPLY UNIT TYPE 1325/1, 2 OR 3 | | | | |
| 1 | V1 | SZ4G | Double-Diode | Mains Rectifier. |

Note : Supply Units Type 1325/4 and 5 use metal rectifiers.

3. TECHNICAL SUMMARY

3.1 Salient Features

3.1.1 Applications

(a) Types of Service

The receiver is designed for the reception of CW and MCW telegraphy and high-grade telephony. It covers the HF range between 2 Mc/s and 60 Mc/s (150 to 5 metres) in five bands. Diversity reception may readily be employed when two or more receivers are available. For this purpose connections are provided for a common oscillator and a common AGC circuit.

(b) RF Input

75-100 ohms for balanced or unbalanced cable or direct connection to aerial.

(c) AF Output

Output connections for 3-ohm loudspeaker, HR or LR telephones and 600-ohm line are provided.

(d) Tropical Use

The receiver is suitable for continuous operation in buildings located in tropical regions.

(e) Power Supplies

Power supplies may be taken from a single-phase 50-60 c/s AC source at any voltage between 200 and 250, or between 90 and 140, or from batteries.

3.1.2 Electrical Characteristics

(a) Circuit (See Fig. 2)

The receiver employs a double superheterodyne circuit with first IF at 1.6 Mc/s and second IF at 465 kc/s. Two signal-frequency amplifiers are followed by a mixer stage with separate first oscillator. The second mixer, a triode-hexode, is followed by two IF stages incorporating the main selective circuits. The detector is followed by two stages of audio-frequency amplification, a beat oscillator for CW reception, an AGC rectifier and a noise limiter.

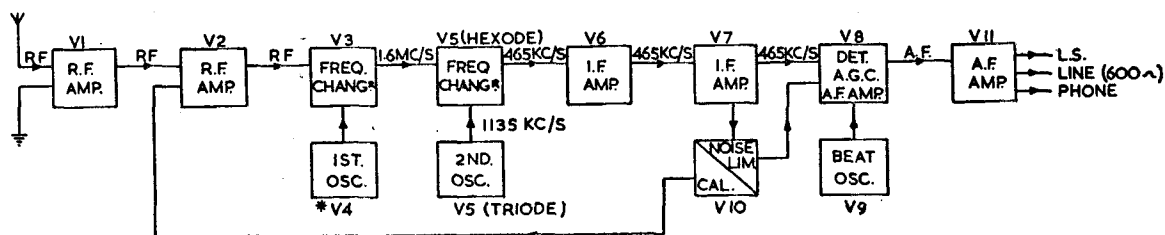

5330

FIG. 2. BLOCK DIAGRAM.

(b) Selectivity

Selectivity of a high order is achieved by the use of a double frequency change for image-signal rejection and by the use of double crystal band-pass filters for rejection of adjacent-channel interference. The selectivity can be varied to suit all conditions of service.

(c) Sensitivity

The sensitivity is good on all ranges. It is limited only by the inherent noise level in the first stage.

(d) **Low Noise Level**

By careful design the inherent receiver noise at all frequencies below 30 Mc/s is reduced to the theoretical limit set by the thermal agitation of the first tuned circuit.

(e) **AGC**

The automatic gain control, adjustable for the type of signal being received, enables wide fluctuations in signal strength to be tolerated.

(f) **Thermal Stability**

Temperature compensation of the first oscillator stage reduces the frequency drift to a low figure.

(g) **Crystal Control**

Crystal control of the first oscillator may be employed on any chosen spot frequency between 2 Mc/s and 30 Mc/s.

(h) **Desensitising**

A desensitising circuit enables the receiver to be fully or partly muted during transmission.

(i) **Metering**

A switched meter reads anode feeds or acts as a tuning indicator.

3.1.3 Tuning

(a) **Single Control**

Single-control tuning is employed with slow and fast motion. A frequency-calibrated main scale and a high-discrimination logging scale are fitted.

(b) **Band-Spread**

A band-spread control covers ± 4 kc/s at any frequency in the range of the receiver by tuning the second oscillator.

(c) **Calibration Checking**

Receivers are individually calibrated and a crystal-controlled calibration-checking oscillator enables the main scale readings to be verified and enables the exact frequency of a received signal to be interpolated between check-frequencies separated by 500 kc/s.

3.2 Performance

3.2.1. Sensitivity

In Table 4 the sensitivity is expressed as the input voltage required to give a 20 db signal to noise ratio on an unmodulated signal or a 10 db signal to noise ratio on a signal modulated 40% at 400 c/s. The voltage is measured at the output terminals of a signal generator, connected through 75 ohms to the aerial terminals of the receiver. The pass-band switch is set at 8000 c/s.

3.2.2 Frequency Drift

The frequency drift without crystal control is shown in Table 4. Typical curves are shown in Fig. 16.

With crystal control the long-period stability is increased to better than 0.01% at all frequencies between 2 and 30 Mc/s under extreme conditions, while under normal conditions, after thermal equilibrium is attained, the frequency is stable to within ± 2 parts in one million per degree centigrade.

3.2.3 Selectivity

(a) **Image Protection**

The amount by which the image signal is attenuated is shown in Table 4.

(b) Adjacent-channel Protection

The adjacent-channel selectivity of the 465 kc/s intermediate-frequency amplifier is shown in Table 3.

TABLE 3. ADJACENT CHANNEL SELECTIVITY

| Bandswitch Position | Bandwidth c/s. | |
|---------------------|----------------|-----------|
| | at -6 db | at -40 db |
| 1,000 | 1,000 | 4,000 |
| 3,000 | 3,000 | 8,500 |
| 8,000 | 8,000 | 18,000 |
| 13,000 | 13,000 | 30,000 |

Figure 12 shows typical IF response curves for the four positions of the pass-band switch.

(c) Two Signal Generator Selectivity

The overall selectivity at 2.2, 5.0 and 10 Mc/s is shown in Fig. 13.

(d) Note Filter

The LF filter is tuned to a nominal frequency of 1,000 c/s. The bandwidth is between 100 and 150 c/s at -6 db and between 200 and 400 c/s at -20 db. The insertion loss is not more than 3 db. A typical response curve is shown in Fig. 11.

3.2.4

TABLE 4. RF PERFORMANCE

| Wave Band | Frequency Range Mc/s | Sensitivity | Image Signal Protection | Frequency Drift (Per hour) |
|-----------|----------------------|-----------------|-------------------------|----------------------------|
| 1 | 2 to 4 | 1 to 2 μ V | \leq 80 db | $<$ 0.01 % |
| 2 | 4 to 8 | 1 to 2 μ V | \leq 70 db | $<$ 0.01 % |
| 3 | 8 to 16 | 1 to 2 μ V | \leq 65 db | $<$ 0.01 % |
| 4 | 16 to 24 | 2 to 4 μ V | \leq 55 db | $<$ 0.02 % |
| | 24 to 32 | 2 to 4 μ V | \leq 40 db | $<$ 0.02 % |
| 5 | 32 to 60 | 7 to 14 μ V | \leq 20 db | |

3.2.5 Fidelity

The overall frequency response in the four positions of the passband switch is shown in Fig. 14, and the response of the audio frequency circuits is shown in Fig. 10.

3.2.6 Automatic Gain Control (See Fig. 15)

The output does not increase by more than 9 db when the input signal is increased to 60 db above the levels stated in the Sensitivity column of Table 4. The time constant can be selected to suit the working conditions.

3.2.7 Output

1 mW to HR or LR telephones
200 mW to 600-ohm line
or 200 mW to 3-ohm loudspeaker

3.2.8 Power Consumption

Mains : 90 watts (approx.)
Batteries : 65 mA at 300V ; 3.7A at 6.3V.

4. GENERAL DESCRIPTION

The CR.150/3 is a bench-mounted model, as shown in the illustration, Fig. 1.

The CR.150/3A is electrically identical but is constructed for mounting in an upright floor-standing cabinet which may house two or more receivers with or without associated apparatus.

The receiver and power supply unit are two separate assemblies. In each case the components are mounted on a chassis which can be withdrawn for servicing. A hinged lid on the bench-mounted version of the receiver gives access to the valves and main components.

Either of two types of power unit may be supplied with the receiver, as shown in Table 5.

TABLE 5. SUPPLY UNIT TYPES

| | Valve Rectifier | Metal Rectifier |
|-----------------|-----------------|-----------------|
| Bench Mounted | Type 1325/1 | Type 1325/4 |
| Rack Mounted | Type 1325/2 | — |
| Cabinet Mounted | Type 1325/3 | Type 1325/5 |

For all future supplies the metal rectifier editions will be made.

4.1 Controls

The positions of the controls are shown in Figs. 4, 7 and 8.

Section 7 describes their operational use.

The following controls are fitted :

(a) **Power Supplies**

These are normally switched on the supply unit. The receiver switch S17 is employed when batteries are used.

(b) **Band Change**

The switches S1-S7 select one of the five wavebands :

TABLE 6. WAVEBANDS

| Band | Frequency Range, Mc/s |
|------|-----------------------|
| 1 | 2 to 4 |
| 2 | 4 to 8 |
| 3 | 8 to 16 |
| 4 | 16 to 32 |
| 5 | 32 to 60 |

The band-switch automatically displays the correct frequency scale on the calibration drum.

(c) **Tuning**

The main tuning scale is calibrated directly in frequency. Receivers are individually calibrated during factory tests.

The main tuning control, slow and fast motion, rotates the ganged variable condensers C1-C4. The control moves the pointer across the frequency scale and also rotates the logging scale discs. The logging scale (see Fig. 5) has an equivalent length of 18 feet and its 1,250 divisions can be read to one quarter division. At 20 Mc/s one scale division is equal to a 12 kc/s change of frequency.

The electrical band-spread control is normally set to central zero. It is calibrated in kc/s and gives a change of frequency of up to ± 4 kc/s, at any frequency in the range of the receiver, by tuning the second oscillator.

The aerial trimmer enables the input circuit to be tuned to maximum sensitivity.

(d) **Selectivity**

The PASS-BAND switch introduces crystal filters into the IF circuits. In the 100 C/S position a note-filter is switched into the AF circuit.

(e) **Operational Switch**

This switches in or out the automatic gain control and switches on the beat-oscillator in the CW position. It also controls the calibration checking oscillator.

(f) **Gain Controls**

The HF GAIN control rotates the ganged potentiometers P3 and P4 in the RF and IF bias circuits. The LF GAIN control rotates the potentiometer P2 in the grid circuit of the first AF amplifier portion of V8.

(g) **Meter Switch**

This enables the valve anode currents to be checked as discussed in Section 7. The meter also serves as a signal indicator.

(h) **Preset Controls**

The desensitising control is operated through a small cover in the front panel. Adjustment of this and the other preset controls, which include the signal-indicator zero setting and the beat-oscillator frequency, is explained in Sections 6 and 7.

4.2 Component Locations

The component positions are shown on the upper deck plan, Fig. 7 and the lower deck plan, Fig. 8. The arrangement of the fixed condenser and resistance assembly boards is shown in Fig. 9 a, b, c and d. A paster inside the lid of the receiver shows the valve types and positions.

4.3 External Connections

These are discussed in detail in Section 6. Fig. 3 shows the rear terminal board, on which are assembled all external connectors with the exception of the headphone jacks which are on the front panel.

(a) **Aerial Input**

The input circuit is primarily intended for connection to a balanced twin screened feeder or to an unbalanced coaxial cable. It may also be connected directly to an aerial of suitable dimensions.

(b) **Outputs**

Outputs to landline and headphones are available. The line output is unaffected by the insertion of headphones for local monitoring.

(c) **Power Supplies**

The power supplies are derived from the separate, AC energised, power unit or from batteries. The power unit and its connector cord are normally supplied with the receiver.

(d) **Diversity Reception**

For special applications connected with diversity reception provision is made for connection to an external oscillator and to an external AGC circuit and for the receiver output to be taken at 465 kc/s.

(e) **Desensitising**

Terminals are provided for connecting the desensitising circuit to external apparatus.

4.4 Mechanical Design

The receiver is a chassis assembly housed in a steel case with hinged lid. Valve changing and internal adjustments for normal operation can be done without removing the chassis from its case. Withdrawal for servicing requires only the removal of two coin-slot screws.

The supply unit is of similar construction.

The receiver chassis is of the inverted tray type with the valves, IF transformers, main tuning condenser, etc., on the upper deck and the control switches, fixed condensers and resistors, etc., on the underside. The RF circuits are on a central sub-assembly which is insulated from the main chassis to reduce spurious couplings.

Component sub-assemblies include the main tuning condenser with calibration scales, RF coil unit, oscillator coil unit, IF circuits and filters and AF filter. Spares of these component units may be stocked for rapid servicing.

5. CIRCUIT DESCRIPTION

5.1 General Circuit Arrangement (See Fig. 2)

The receiver embodies two signal-frequency amplifier stages followed by a pentode mixer with a separate first frequency-change oscillator.

The first intermediate frequency is 1.6 Mc/s. The first mixer is coupled directly to the second mixer at this frequency through a pair of coupled circuits. The second frequency change to 465 kc/s is made with a triode-hexode, which is followed by a two-stage amplifier incorporating the main selective circuits and crystal filters.

The 465 kc/s intermediate-frequency output is rectified by two diodes to provide AGC and audio-frequency outputs. The triode section of the double-diode triode acts as first audio-frequency amplifier and is followed by the output stage. The beat oscillator is coupled to the signal diode.

5.2 Signal Frequency Circuits (See Fig. 17)

The aerial input is taken to a coupling winding on the tuned grid coil of the first signal-frequency amplifier. The two ends of the coupling coil are connected to concentric screened sockets, the plugs of which are suitable for use with Uni-Radio 6 or Uni-Radio 18 RF cable. For balanced inputs both connectors are used, but for unbalanced inputs the centre and outer of one socket are joined, the other socket being used for the aerial connection.

The gain of the signal-frequency amplifier is sufficient to make the first circuit noise equal to, or greater than, other receiver noise at all frequencies up to 32 Mc/s (bands 1 to 4). On band 5 (32–60 Mc/s) the first valve noise is equal to other noise.

The gain of the signal frequency stages is substantially constant on bands 1–4. Special coupling circuits are used to attain this.

Considerable precautions have been taken to ensure a high order of stability for the first frequency-change oscillator. The tuning condenser is provided with a very robust frame, and the thickness of the vanes in the oscillator section, and the spacing between vanes, are greater than usual. The coils for bands 3 and 4 are wound on ceramic formers. In addition to such precautions for reducing the thermal frequency drift of the oscillator the residual frequency drift is still further reduced by a thermally operated compensating condenser.

The first oscillator may be crystal controlled on any one selected frequency between 2 Mc/s and 30 Mc/s.

The signal-frequency stages, mixer, first oscillator and 1,600 kc/s IF transformer are mounted on a removable plate, and this sub-assembly is mounted in the centre of the main receiver chassis on insulated bushes, which reduces the possibility of coupling between the signal-frequency circuits and the second and third oscillators. By this means pick-up of harmonics of these oscillators is reduced to a low level.

5.3 Intermediate Frequency Circuits

The 1,600 kc/s IF unit is mounted on the HF sub-assembly, and output is taken by a flexible screened lead to the grid cap of the second mixer valve on the main receiver chassis.

The second mixer is a triode hexode with its oscillator operating at a frequency of 1,135 kc/s. This oscillator has a front-of-panel controlled trimmer condenser giving a variation of four kc/s on each side of the centre zero. This is the band-spread control and it tunes the receiver across the selectivity curve of the signal frequency and first intermediate-frequency circuits; these are designed so that the mistuning by the band-spread control does not lead to more than one decibel of asymmetry at the worst point.

The second IF amplifier (465 kc/s) controls the overall selectivity of the receiver for all positions of the selectivity switch except the 100 c/s pass-band. The two widest pass-bands are determined by variations of coupling between the two tuned circuits.

For the 3,000 c/s pass-band a double crystal filter is introduced and a second double crystal filter reduces the pass-band to 1,000 c/s. Both these double crystal filters remain in circuit when the tuned AF circuit is introduced.

5.4 Beat Oscillator and Signal Detector

The beat oscillator is electron coupled to the signal diode, which obtains its intermediate-frequency input from the secondary of the final intermediate frequency transformer. The oscillator amplitude is such that, whilst it will fully modulate the largest signal at the signal diode, it will not operate the automatic gain control diode. The efficient screening of the beat oscillator circuit prevents its harmonics from interfering appreciably with the signal-frequency input.

5.5 Audio Frequency Circuits

The triode audio-frequency amplifier part of V8 is resistance capacity coupled to the output valve VII, except in the 100 c/s position of the pass-band switch, in which case the coupling is through a 1,000 c/s band-pass filter. The audio-frequency gain is appreciably the same with or without the filter.

5.6 Automatic Gain Control Circuits

The input for the automatic gain control diode is taken from the primary of the final intermediate frequency transformer. The automatic gain control voltage is applied directly via the resistor R.79 to the second mixer and the first IF amplifier, and through the potentiometer formed by R.46 and R.47 to the two high-frequency amplifiers. A choice of three time constants is available by using a selector board inside the receiver. This facility is needed for high-speed recording applications.

The automatic gain control is switched in and out by the operational switch. The latter covers six positions; i.e., stand-by, beat oscillator on (with and without AGC), beat oscillator off (with and without AGC) and crystal calibrator and beat oscillator on.

5.7 Noise Limiter

The double-diode section of V10 operates as an impulse noise-limiting circuit. The "series" diode at Pin 5, in series with the two resistors R50 and R84, is connected across the resistor R42, which is part of the detector load. This diode is normally conducting in the presence of a signal by virtue of the fact that its anode is at a positive potential relative to the cathode. When it is conducting the audio-frequency potential developed at its cathode will be conveyed to the grid of the first AF amplifier, the triode section of V8. The junction of R50 and R84 is held at earth potential to AF signals by the condenser C115, and the time constants of the circuit are such that a noise impulse of short duration, equivalent to more than 100% modulation of the signal being received, will cause an instantaneous fall in potential of the anode V10 pin 5 to a value lower than that of the cathode. The diode will thus cease to conduct.

Additional protection is afforded by the rectifying action of the "shunt" diode at V10 pin 4 which will by-pass to earth through C115 any excessive AF signal which may appear at the anode before the series diode has ceased to conduct.

5.8 Crystal Calibrator

The triode portion of V10 can be switched to work as a crystal-controlled oscillator. The frequency of this oscillator is controlled by an AT-cut low temperature-coefficient crystal. The circuit is dimensioned to give strong harmonics of the 500 kc/s oscillation in its output, which is coupled to the first tuned circuit of the receiver. The amplitude of these harmonics is sufficient for checking the calibration at any multiple of 500 kc/s up to 30 Mc/s.

5.9 Desensitising Circuit

The RF and IF cathode bias can be increased by introducing a variable resistance P5 between earth and the gain control potentiometers. Terminals at the back of the receiver enable this resistance to be connected to the keying relay or to back contacts on the transmitting key. The receiver can thus be fully or partially muted during transmission, when a common frequency is employed.

5.10 Diversity Working

For diversity use there is provision for injecting a common first-oscillator output into the receiver. This is connected through a concentric socket at the back, a small wiring change being necessary at the oscillator tuning condenser above the chassis, see Fig. 21. It is also necessary to remove the oscillator valve when working with an external common oscillator.

The AGC connections are taken to terminals at the back of the case. When the receiver is used by itself, these are joined together. For diversity use they can be connected to a common AGC circuit on the combining unit.

5.11 Supply Unit (See Fig. 18)

For power supply from AC mains the Supply Unit Type 1325 is provided. The Types 1325/1, /2 and /3 employ a valve rectifier and electrolytic smoothing condensers. The types 1325/4 and /5 employ a metal rectifier and paper dielectric condensers.

The mains are connected to a two-pin plug on the back of the chassis. From this plug connection is made through the ON/OFF switch and 2-amp. mains fuses to the transformer primary. Tappings are provided for any standard supply voltage in the 110-volt or 220-volt range. An HT fuse, rated at 500 mA, is connected between the HT secondary centre tap and earth. The unit contains its own HT smoothing filter.

The 300-volt DC and 6.3-volt AC outputs are connected to a 5-pin socket on the back of the chassis. A connector cord and plug convey the supplies to the receiver.

The electrical characteristics of both units are as follows :—

| | |
|---------------|--|
| Input : | 200–250 volts or 90–140 volts 50 c/s single-phase AC. (Tappings at 110, 215, 230 and 250 volts permit adjustment to any available voltage.) |
| Output : | 300 volts 65 mA DC. 6.3 volts 4 amps. AC. |
| Consumption : | 90 watts. |

6. INSTALLATION

6.1 Power Supplies

6.1.1 For Mains Working

The power-supply circuits are contained in a separate unit, supply unit Type 1325. This is connected to a 50 c/s AC supply and the power consumption is approximately 90 watts.

The power transformer primary is tapped to permit connection to any supply voltage between 200 and 250. An extra tapping at 110V enables any low-voltage AC supply between 90 and 140 volts to be used.

It is essential to check that the correct tapping is connected before switching on. Equipments leaving the factory will normally be connected to the 230V tap.

Connection between the supply unit and the receiver is made by a cable terminating in a 5-pin socket. This socket unites with a 5-pin plug at the rear of the receiver.

The fuses are of the cartridge type. The mains fuses are rated to carry 2 amperes and the HT fuse is rated to carry 500 milliamperes.

The AC mains connector should be fitted with a 5-amp. plug.

The supply unit may be located in any convenient position near the receiver.

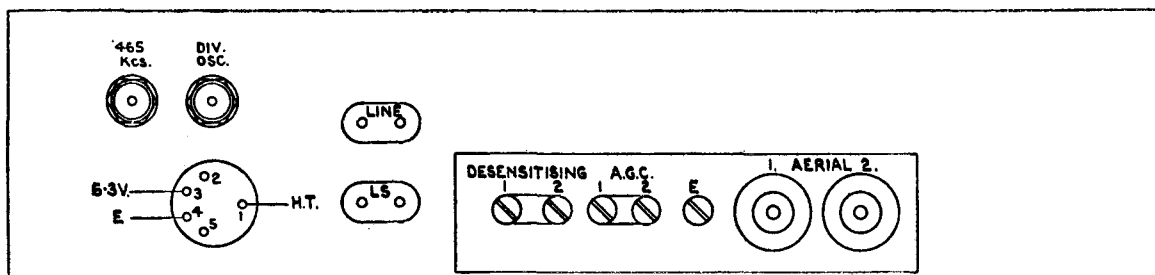

5331

FIG. 3. TERMINAL AND SUPPLY BOARD.

6.1.2 For Batteries and other Supplies

At the rear of the receiver is a 5-pin plug carrying the HT and LT connections (see Fig. 3).

These supplies should be :

| | | | | |
|-------|-------------------------------------|------|-------|----------|
| Pin 1 | HT+ | 300V | 65 mA | DC |
| Pin 3 | LT+ (or AC) | 6V | 3.7 A | AC or DC |
| Pin 4 | Common negative at earth potential. | | | |

Protective fuses should be fitted on the supplies.

6.2 Aerial Input

Aerial input sockets are located on the back of the receiver, for a balanced input of 75-100 ohms. An unbalanced input from a single co-axial cable may be connected to one socket while the inner and outer conductors of the other socket are connected together. With the same arrangement direct connection may be made to an aerial.

6.3 Outputs

A two-pin plug and socket on the back of the receiver labelled LS is provided for connection to a 3-ohm loudspeaker.

A similar two-pin plug and socket labelled LINE, also on the back of the receiver, is provided for connection to a 600-ohm line.

Two telephone jacks, situated on the front panel, are for use with either high or low resistance telephones. Two of either type may be used, but one high and one low resistance pair cannot successfully be connected in parallel.

6.4 Automatic Gain Control

6.4.1 Diversity Operation

To enable the receiver to be used as part of a diversity equipment, the automatic gain control line is brought out to two terminals labelled AGC on the back of the receiver, thus making it possible to control all the receivers of a diversity equipment from a common AGC source. For normal receiver working these two terminals are strapped together.

6.4.2 AGC Time Constant Plug Board S18

This plug board, see Figs. 17 and 7, has three positions whereby the time constant of the AGC circuits may be varied.

The middle position gives a time constant of approximately 0.2 secs. for both the CW and MOD positions of the operational switch. This position is used when the receiver forms part of a diversity equipment, where the time constant may then be changed by the control on the combining unit.

The position labelled $0.5\mu\text{F}$ gives a time constant of approximately 0.2 secs. for the MOD position and 1.75 secs. for the CW positions of the operational switch. This position should be used for normal receiver working.

The third position labelled $0.1\mu\text{F}$ gives a time constant of approximately 0.5 secs. for both the CW and MOD positions of the operational switch. This position is used for high-speed recording when the receiver is used with a Type RB.150 Bridge.

6.5 Diversity Connections

The socket labelled DIV.OSC at the back of the receiver is for use when the receiver forms part of a diversity equipment. It enables two or more receivers to be fed from a common first oscillator and when this is done the oscillator valve V4 is removed from its socket. The connections from the external socket to the first oscillator circuit are shown in Fig. 21, which gives the connections for normal and for diversity reception.

An output at 465 kc/s is provided in case it is desired to use an IF operated unit in conjunction with the receiver.

6.6 Desensitising Facilities

In a combined transmitting and receiving installation it may be necessary to mute the receiver during transmission. For this purpose two terminals labelled DESENSITISING are fitted to the back of the receiver. In general use they are connected together. When muting is employed they are connected by a screened pair to the transmitter relay or back contacts on the transmitting key.

When the key is pressed the RF and IF cathode bias is increased by introducing all or part of an additional 5,000-ohm resistance, P5, at the earthy end of the HF and IF gain controls P3 and P4.

The potentiometer P5 is mounted above the HF GAIN control and it may be adjusted by a screwdriver after moving the cover marked D on the front panel. It is adjusted so that the operator hears the transmitter at a convenient level.

7. OPERATION

Assuming that the installation and initial adjustments have been carried out in accordance with Section 6, the following instructions give all the information essential for the correct use of the receiver.

Operators are urged to study the circuit description in order to make the most of the receiver by an intelligent use of the controls.

Note that certain adjustments which are not used in the normal operation of the receiver, but should be attended to when first installing it, are dealt with in Section 6. These refer to selection of the optional AGC time constants provided, arranging the receiver for use as part of a diversity equipment and adjustment of the desensitizing control.

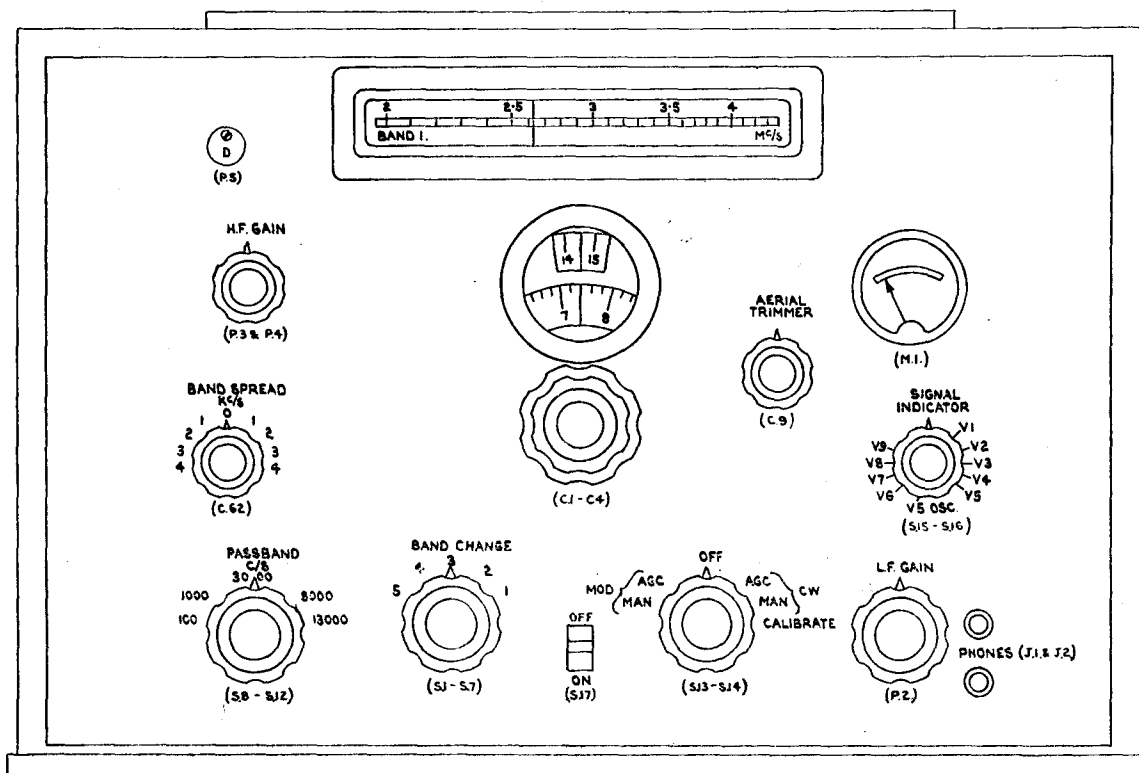

FIG. 4. FRONT PANEL (CONTROL LAYOUT)

5332

7.1 Operating Sequence

- (a) Switch on supplies to power unit. Indicating lamp and receiver scale lamps should light up.
- (b) Switch on supplies by the receiver switch only when batteries are used.
- (c) Set operational switch to CW/MAN.
- (d) Set PASS-BAND switch to 3,000 c/s.
- (e) Set LF GAIN to mid-position.
- (f) Set HF GAIN to maximum, clockwise, reducing if necessary to give comfortable level in 'phones.
- (g) Set BAND-CHANGE switch to frequency band required. The frequency calibration for each band is automatically brought into view on the calibration drum. The frequency-ranges are given in paragraph 3.2.4.
- (h) Adjust pointer on calibration scale to desired frequency by larger tuning knob, and locate the wanted signal by the use of the small knob. If RT (telephony) is to be received change operational switch to MOD/MAN and retune slightly. Reduce signal to suitable level by turning HF gain control counter-clockwise.
- (i) Always switch off supplies to power unit as well as receiver when closing down for long periods. During short stand-by periods the HT to certain stages may be cut off by putting the operational switch to the OFF position.

7.2 Use of PASS-BAND Switch

The 13,000 c/s position gives the best intelligibility of speech and makes tuning broader, but it can only be used when little interference is present. Switching to 8,000 c/s, 3,000 c/s and then 1,000 c/s cuts down interference progressively, but the signal must be tuned more carefully and accurately. The 100 c/s position demands very careful tuning and is only used for CW. It is most suitable for bands 1 and 2. In this position a 100 c/s wide note filter is combined with the 1,000 c/s band-pass filter.

N.B.—When receiving CW with pass-band switch at 13,000 c/s or 8,000 c/s, it will be found that on tuning through zero beat, the beat note obtained is equally strong on both sides of zero, but when using positions 3,000 c/s, 1,000 c/s and 100 c/s one side will give a stronger note than the other. Always tune to the stronger of the two.

7.3 Use of AGC

AGC should be switched off when searching or in the presence of strong interference.

7.4 Use of Gain Controls

Either AGC on, HF GAIN at maximum, and LF GAIN as desired,
or AGC off, HF GAIN as desired, and LF GAIN at approximately mid-position.

7.5 Use of Calibrator

When the operational switch is in the CALIBRATE position a 500 kc/s crystal oscillator is switched on and a calibrating signal is heard every 500 kc/s up to 30 Mc/s. The calibrating signal can be distinguished from incoming signals by switching from the CALIBRATE position to the CW position.

7.6 Use of Signal Indicator and Meter Switch

With the switch in the SIGNAL INDICATOR position the meter acts as a tuning indicator. It is necessary to set this meter to give zero reading in the absence of a signal. This is done as follows :—

Remove the receiver from its case.

Set the operational switch in the MOD-AGC position and the HF GAIN control near maximum.

Adjust the tuning control to a silent point.

Adjust the variable resistance P1 (see Fig. 8) in the anode circuit of V6, until zero reading is obtained.

The other positions of this switch will meter the valve feeds of V1 to V9 and the meter should read between 3 and 7 for all these valves when the HF GAIN control is at maximum.

7.7 Use of Logging Scale

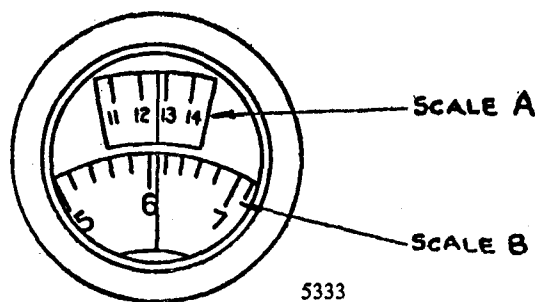

FIG. 5. LOGGING SCALE

This scale enables the operator to reset the receiver accurately to a station that has once been found. Some slight allowance for initial frequency drift should be made if the receiver has been running for less than two hours.

Read the divisions from left to right, main divisions on the upper scale and sub-divisions on the lower scale. Note that the reading decreases with increasing frequency.

The approximate discrimination of the scale at the bottom, middle and top frequency of each band is given in Table 7.

TABLE 7. LOGGING SCALE DISCRIMINATION

| | kc/s per small division (0.02) | | |
|--------|--------------------------------|---------------|------------|
| | <i>Bottom</i> | <i>Middle</i> | <i>Top</i> |
| Band 1 | 1 | 2 | 2.5 |
| Band 2 | 2 | 4 | 5 |
| Band 3 | 4 | 8 | 10 |
| Band 4 | 8 | 16 | 20 |
| Band 5 | 16 | 28 | 32 |

7.8 Use of Crystal Control

The receiver may be crystal controlled by changing over the link on S19 plug board (see Fig. 7) and by removing the valve V4 from its socket and plugging it into the holder marked V4A.

The crystal CRY.1 should be plugged into its holder, and the main tuning condenser must be tuned to the required frequency.

N.B.—The crystal frequency will always be 1.6 kc/s higher than the signal frequency.

7.9 Adjustment of the Beat Oscillator

The preset adjustment of the beat oscillator must be set correctly in the first instance and checked periodically to make the best use of the high selectivity of the receiver in the narrow pass-band condition. The adjustment of the condenser C73 is controlled by a knob in the top of the can containing the beat oscillator circuit (see Fig. 7). Three marks indicate approximately the positions for 1,000 c/s above the IF, zero beat and 1,000 c/s below the IF.

To check the adjustment proceed as follows :—

Set the PASS-BAND switch to 100.

Set the BANDCHANGE switch to BAND 1.

Tune to any silent point.

Adjust C73 until the receiver noise reaches a maximum.

7.10 Warming Up

The receiver takes a few minutes to warm up, and about 15 minutes to reach stability. Use OFF position of operational switch to switch off for short breaks, as valve heaters are left on and receiver is ready for immediate use.

8. MAINTENANCE AND SERVICING

8.1 Maintenance

The following sub-sections cover servicing the receiver according to the apparatus and facilities available. Apart from servicing for specific faults which may arise routine maintenance calls for little comment.

It cannot be too strongly stated that random adjustments to trimmer condensers, etc., should never be undertaken. Such adjustments should only be touched by staff having the necessary experience, after reading the servicing instructions below.

Always keep the lid of the receiver closed to avoid dust. Avoid harsh treatment of the aerial and supply sockets, e.g., do not drop them on the ground at the end of their leads. Occasional lubrication of the click register and wave-change mechanisms with a light machine oil of good quality is desirable, but do not lubricate the actual switch wafers and contacts under any circumstances. Do not handle the main tuning condenser unless it is absolutely essential to remove dust or other deposit on the plates, and then use nothing harsher than a feather or pipe cleaner gently between the plates. Tighten up the grub screws holding the operating handles on to their spindles if they work loose under constant use rather than let them tend to scratch a track on the spindle through slipping, and do not try to force the control knobs beyond their obvious stop position.

Always switch off before servicing the receiver or power supply unit internally.

The receiver is safe when supplies are switched off on the supply unit. The supply unit is only completely safe when isolated from the mains.

8.2 Emergency Servicing

8.2.1 Fuse Replacements

The supply unit is fitted with three cartridge fuses which should be examined in case of failure in supplies to the receiver. (See Fig. 18). The supply must be switched off before these are touched.

8.2.2 Valve Replacements

Keep a log of valve feeds indicated on the meter and replace any of the valves V1-V9 which drop in feed below their correct minimum. All valve feeds should read between 3 and 7 on the meter with the HF GAIN at maximum.

For measuring the feeds of valves V10 and V11 and for accurate measurement of other valve feeds, use an Avometer or similar external instrument. The bottom of the receiver cabinet should be removed and the meter clipped across the resistances shown in Table 9.

8.2.3 Replacing Electrolytic Condensers

The electrolytic condensers in the supply units Types 1325/1, 2 and 3 may need replacing. The connections are soldered. Care should be taken to maintain the correct polarity. The Types 1325/4 and 5 use paper dielectric condensers.

8.2.4 Replacing the Calibration Drum Drive Cord (See Fig. 20)

- (a) Remove receiver from case.
- (b) Remove all knobs and disconnect meter.
- (c) Remove front panel.
- (d) Fit a knob temporarily to the band-switch and set this to BAND 5.
- (e) Check that all oak switches are correctly set to this band.
- (f) Take off the calibrated drum by removing bracket and cheek at right-hand end and pulling the drum out of the left-hand cheek.
- (g) Take 6 feet of cord, bring ends together, and fold double. Pass loop through eyelet on the left-hand cheek A.
- (h) Tie knot in the loop end and locate in hole of cheek A.
- (i) Take one cord (call this the LH cord). Pass this cord straight down over pulley B, then on to pulleys C and D and round the operating drum E to the hole in E.
- (j) The other cord (RH cord) is taken $1\frac{1}{2}$ times round A and down to pulleys G and F and round to the hole in E.
- (k) Both ends of the cord are then passed through the end of the spring in E and tied off.

8.2.5 Replacing the Pointer Drive Cord

- (a) Set 0-25 logging scale at 22.
- (b) Release pointer from old cord. Pull cord out through $1\frac{1}{4}$ in. diameter inspection hole in front plate of drive, but do not detach from spring.
- (c) Thread new cord, which should be 44 inches long, through pointer slider and pass ends round the drum, the right-hand cord clockwise and the left-hand cord counter clockwise. Tuck the cords through the hole in periphery of drum. There should now be approximately $1\frac{1}{3}$ turns of cord on the drum.
- (d) Pull spring out through hole in plate by means of old cord. Thread ends of new cord through loop of spring and secure with a large knot about 1 inch from end. Cut off old cord.
- (e) Pull cord back through hole in drum, thus extending the spring, and ease over small pulleys at each end of pulley guide.
- (f) Fix pointer lightly to cord. Pointer to be at middle of scale when logging scale is at 12.5.
- (g) Check position of pointer on calibration scale by tuning receiver to a station of known frequency near middle of scale. Fix pointer firmly to cord, taking care not to cut it.
- (h) Replace panel and knobs.

8.3 Circuit Checks

In the event of a receiver failure not due to valves, fuses, etc., endeavour to narrow down the possible location of fault by a logical sequence of tests. For example, a failure observable on only one of the frequency bands would exonerate the IF and AF circuits; a failure on the narrowest position of the pass-band switch would probably be due to the LF filter, etc., etc.

If a fault can be narrowed down, it can very often be traced by the use of an Avometer only and the following tables give circuit checks which should be of assistance.

8.3.1 General Circuit Check

Remove valves and lamps.

Remove links from AGC terminals and desensitising terminals.

Set the desensitising control at maximum.

Set the HF and LF gain controls at maximum.

Set the operational switch to CALIBRATE.

Set the selectivity control at 100 c/s.

Set the band switch at BAND 1.

Turn P1 fully clockwise.

The circuit resistance values given in Table 8 should be within $\pm 20\%$.

TABLE 8. CIRCUIT CHECKS

| Test Points | Main Switch at ON |
|--------------------------------------|-------------------|
| Supplies plug E pin and chassis | 0 |
| Supplies plug HT+ and chassis | 150,000 Ω |
| Supplies plug LT and chassis | ∞ |
| Loudspeaker sockets | 1.1 Ω |
| Line Sockets | 62 Ω |
| Phone Jack | 4,700 Ω |
| AGC terminal 1 and earth | 2.3M Ω |
| AGC terminal 2 and earth | ∞ |
| Desensitising 1 and earth | 0 |
| Desensitising 2 and earth | 5,000 Ω |
| Aerfials 1 and 2 and earth | ∞ |
| Aerial 1 and Aerial 2 | 0.5 Ω |
| IF Output and Earth | 0.2 Ω |
| Diversity Oscillator Input and earth | ∞ |
| Diversity Oscillator Input and C.57 | 0 |

8.3.2

TABLE 9. VALVEHOLDER CIRCUIT CHECK

| Test Points | V1 | V2 | V3 | V4 | V5 | V6 |
|-----------------------|----------------|----------------|----------------|----------------|----------------|----------------|
| E and top cap | — | — | — | — | 3 M Ω | 3 M Ω |
| E and Pin 1 | ∞ | ∞ | ∞ | ∞ | ∞ | ∞ |
| E and Pin 2 | ∞ | 197 k Ω | 160 k Ω | 160 k Ω | 0 | 0 |
| E and Pin 4 | 0 | 0 | 100 k Ω | 160 k Ω | 183 k Ω | 300 k Ω |
| E and Pin 5 | 0 | 0 | 0 | ∞ | 100 k Ω | 0 |
| E and Pin 6 | 220 Ω | 220 Ω | 3,400 Ω | 0 | 250 k Ω | ∞ |
| E and Pin 6 (HF min.) | 2,200 Ω | 2,200 Ω | 3,400 Ω | 0 | 250 k Ω | ∞ |
| E and Pin 7 | 0.5 M Ω | 0.5 M Ω | 100 k Ω | 10 k Ω | ∞ | ∞ |
| E and Pin 8 | 0 | 0 | 0 | ∞ | 330 Ω | 1,000 Ω |
| E and Pin 8 (HF min.) | 0 | 0 | 0 | ∞ | 5,300 Ω | 6,000 Ω |
| E and Pin 9 | 0 | 0 | 0 | 0 | — | — |
| LT and Pin 1 | 0 | 0 | 0 | 0 | ∞ | ∞ |
| LT and Pin 7 | ∞ | ∞ | ∞ | ∞ | 0 | 0 |
| HT+ and Pin 2 | ∞ | 52 k Ω | 15 k Ω | 16 k Ω | 150 k Ω | 150 k Ω |
| HT+ and Pin 3 | 10 k Ω | 10 k Ω | 15 k Ω | 16 k Ω | 10 k Ω | 3,200 Ω |
| HT+ and Pin 4 | 150 k Ω | 150 k Ω | 250 k Ω | 16 k Ω | 38 k Ω | 155 k Ω |
| HT+ and Pin 5 | 150 k Ω | 150 k Ω | 150 k Ω | ∞ | 250 k Ω | 150 k Ω |
| HT+ and Pin 6 | 150 k Ω | 150 k Ω | 153 k Ω | 150 k Ω | 100 k Ω | ∞ |

| Test Points | V7 | V8 | V9 | V10 | V11 | V12 |
|-----------------------|---------------------------------|------------------|----------------|----------------|----------------|----------------|
| E and top cap | 3 Ω | 1 M Ω | 110 k Ω | 1.1 M Ω | — | — |
| E and Pin 1 | ∞ | ∞ | 152 k Ω | ∞ | ∞ | 152 k Ω |
| E and Pin 2 | 0 | 0 | 0 | 0 | 0 | 0 |
| E and Pin 4 | 160 k Ω | ∞ | 370 k Ω | 0.5 M Ω | ∞ | 152 k Ω |
| E and Pin 5 | 0 | 133 k Ω | 0 | 33 k Ω | 560 k Ω | 470 k Ω |
| E and Pin 6 | 2 k Ω | 152 k Ω | ∞ | ∞ | 150 k Ω | — |
| E and Pin 6 (HF min.) | (No change from above readings) | | | | | |
| E and Pin 7 | ∞ | ∞ | ∞ | ∞ | ∞ | — |
| E and Pin 8 | 470 Ω | 11 k Ω | 10 k Ω | 0 | 1 k Ω | — |
| E and Pin 8 (HF min.) | 470 Ω | 11 k Ω | 10 k Ω | 0 | 1 k Ω | — |
| E and Pin 9 | — | — | — | — | — | — |
| LT and Pin 1 | ∞ | ∞ | ∞ | ∞ | ∞ | ∞ |
| LT and Pin 7 | 0 | 0 | 0 | 0 | 0 | — |
| HT+ and Pin 2 | 150 k Ω | 150 k Ω | 150 k Ω | 150 k Ω | 150 k Ω | 150 k Ω |
| HT+ and Pin 3 | 2,200 Ω | 69 k Ω | 2,200 Ω | 22 k Ω | 310 k Ω | 5 k Ω |
| HT+ and Pin 4 | 15 k Ω | ∞ | 222 k Ω | 650 k Ω | ∞ | 5 k Ω |
| HT+ and Pin 5 | 150 k Ω | 283 k Ω | 150 k Ω | 200 k Ω | 150 k Ω | 620 k Ω |
| HT+ and Pin 6 | 150 k Ω | 2,200 k Ω | ∞ | ∞ | 0 | — |

8.3.3

TABLE 10. OPERATIONAL SWITCH CIRCUIT CHECK

| Test Points | Switch Position | | | | | |
|---------------------|-----------------|----------------|----------------|----------------|----------------|----------------|
| | Mod. | | Off | CW | | |
| | Man. | AGC | | AGC | Man. | Calibrate |
| HT+ and 2 on S16 | 0 | 0 | ∞ | 0 | 0 | 0 |
| HT+ and 3 on V9 | ∞ | ∞ | ∞ | 2,200 Ω | 2,200 Ω | 2,200 Ω |
| HT+ and 3 on V10 | ∞ | ∞ | ∞ | ∞ | ∞ | 22 k Ω |
| HT+ and 2 on V1 | 52 k Ω | 52 k Ω | 52 k Ω | 52 k Ω | 52 k Ω | ∞ |
| E and Pin 8 on V10 | 1.6 M Ω | 1.6 M Ω | 1.6 M Ω | 1.6 M Ω | 1.6 M Ω | 0 |
| E and top cap on V6 | 47 k Ω | 3 M Ω | 47 M Ω | 3 M Ω | 47 M Ω | 3 M Ω |

8.3.4 Meter Switch Circuit Check

Disconnect the meter from the switch :

TABLE 11. METER SWITCH CIRCUIT CHECK

| Test Points | Switch Position | Resistance Ohms |
|-------------------------|-----------------|------------------------|
| Across R71 | — | 470 \pm 5% |
| 12 on S15 and 12 on S16 | 1 | 2,000-4,000 \pm 10%* |
| 12 on S15 and 12 on S16 | 2 | 96 \pm 5% |
| 12 on S15 and 12 on S16 | 3 | 96 \pm 5% |
| 12 on S15 and 12 on S16 | 4 | 179 \pm 5% |
| 12 on S15 and 12 on S16 | 5 | 56 \pm 5% |
| 12 on S15 and 12 on S16 | 6 | 470 \pm 5% |
| 12 on S15 and 12 on S16 | 7 | 2,200 \pm 5% |
| 12 on S15 and 12 on S16 | 8 | 167 \pm 5% |
| 12 on S15 and 12 on S16 | 9 | 40 \pm 5% |
| 12 on S15 and 12 on S16 | 10 | 250 \pm 5% |
| 12 on S15 and 12 on S16 | 11 | 82 \pm 5% |

* This resistance depends on the position of P1.

8.4 Meter Readings

8.4.1 Voltages and Feeds

The receiver to have its full complement of valves and lamps.

The band switch to be at BAND 1.

The operational switch to be at CALIBRATE.

The meter switch to be at V1.

The receiver to be fed from its power unit.

The voltage or current given in Table 12 to be within \pm 20%, when measured with an Avometer or similar instrument.

TABLE 12. VOLTAGES AND FEEDS

| Test | Test Points | Voltage or Current | |
|-----------------|--|--------------------|---------------|
| | | HF GAIN Max. | HF GAIN Min. |
| HT Volts | HT+ and E | 300 Volts DC | 310 Volts DC |
| Stabilised Line | Pin 1 on V12 and E | 140 Volts DC | 140 Volts DC |
| Heater Line | LT and E | 6.3 Volts AC | 6.3 Volts AC |
| HF Cathode Line | Slider on P3 and E | 0 Volts DC | 3.0 Volts DC |
| IF Cathode Line | Slider on P4 and E | 0 Volts DC | 10.0 Volts DC |
| HT Current | Across S17 with S17 open, the LT side strapped | 65 mA DC | 55 mA DC |
| LT Current | Across S17 with S17 open, the HT side strapped | 3.7A AC | 3.7A AC |

8.4.2 Valve Feeds

The feeds for valves V1 to V10 are measured by connecting a milliammeter across the resistor given in Table 13, and should be within $\pm 20\%$.

The feed for V11 is computed by connecting a voltmeter to read the volts drop across the resistor given in Table 13, and should be within $\pm 20\%$.

TABLE 13. VALVE FEEDS

| Check Feed | Test Points | HF Gain Control | |
|------------|-------------|-------------------|-------------------|
| | | Max. | Min. |
| V1* | Across R7 | 3.0 mA $\pm 20\%$ | 0.1 mA $\pm 20\%$ |
| V2 | Across R14 | 3.0 mA $\pm 20\%$ | 0.1 mA $\pm 20\%$ |
| V3 | Across R18 | 1.9 mA $\pm 20\%$ | 1.9 mA $\pm 20\%$ |
| V4 | Across R22 | 4.0 mA $\pm 20\%$ | 4.0 mA $\pm 20\%$ |
| V5 | Across R30 | 0.7 mA $\pm 20\%$ | 0.2 mA $\pm 20\%$ |
| V5 Osc. | Across R29 | 1.9 mA $\pm 20\%$ | 1.8 mA $\pm 20\%$ |
| V6 | Across R35 | 2.5 mA $\pm 20\%$ | 1.0 mA $\pm 20\%$ |
| V7 | Across R41 | 7.5 mA $\pm 20\%$ | 7.5 mA $\pm 20\%$ |
| V8 | Across R49 | 1.7 MA $\pm 20\%$ | 1.7 mA $\pm 20\%$ |
| V9 | Across R37 | 2.2 mA $\pm 20\%$ | 2.2 mA $\pm 20\%$ |
| V10 | Break HT | 1.0 mA $\pm 20\%$ | 1.0 mA $\pm 20\%$ |
| V11 | Across R53 | 10.0 volts | 10.0 volts |

* The feed for V1 is zero for the CALIBRATE position but can be read for any other working position for the operational switch.

Resistances can be located by reference to Figs. 8 and 9 and valve positions are given in Fig. 7.

8.4.3 Valve Metering

Set the bandswitch to BAND 1. Set the operational switch to CW-MAN.

The meter gives an indication of the valve feeds V1 to V9. The values of meter deflections (not actual current) are as follows :—

| Valve | V1 | V2 | V3 | V4 | V5 | V5(Osc.) | V6 | V7 | V8 | V9 |
|-------------------------------------|-----|-----|-----|-----|-----|----------|-----|-----|-----|-----|
| Gain Control at Max. ($\pm 20\%$) | 4.5 | 4.5 | 4.5 | 3.5 | 3.0 | 6.0 | 5.5 | 5.0 | 5.5 | 4.0 |

8.4.4. Signal Indicator

On the SIGNAL INDICATOR position the meter deflection is adjusted to zero by the potentiometer P1, with the bandswitch on BAND 5, the operational switch in MOD-AGC position and the HF GAIN control near maximum.

The signal indicator sensitivity is such that on BAND 1 with a voltage of 100 μ V applied through 75 Ω to the aerial input at a frequency of 2 Mc/s the meter should read $6.0 \pm 20\%$.

8.5 Receiver Alignment Tests

From the following notes competent staff can check stage by stage gains and response curves by the use of a signal generator, a tone generator and an output meter. The latter should have input impedances suitable for the various output impedances of the receiver, i.e., 3 ohms, 600 ohms and 5,000 ohms. A spare output transformer from another receiver can be used to give the lower impedances from a meter having only a 5,000 ohm impedance, but figures obtained will show the transformer loss of about 3 db.

8.5.1. LF Amplifier Test

A tone generator with known output should be connected to the grid of V8 through a 0.1 μ F condenser. The grid clip should also be attached to the valve top cap. Connect a 3-ohm output meter to the loudspeaker socket.

With an input voltage of 0.2V the LF response should be within -3 and $+1$ db of the level at 1,000 c/s for all frequencies between 100 and 6,000 c/s.

The LF gain should be such that the input required to give the following outputs at 1,000 c/s is :—

TABLE 14. AF OUTPUT

| Input | Output | | |
|------------------|--------------------------|------------------------------|----------------------------|
| | LS terminals (3 ohms) | Line terminals (600 ohms) | Phone Jack (5,000 ohms) |
| 0.2V \pm 0.05V | 50 mW | 50 mW | 1.0 mW |

8.5.2 LF Filter Adjustment and Test

Apply 0.3V at 1,000 c/s to the grid of V8. Clip a 100,000-ohm resistor across the left-hand circuit of the LF filter and tune the right-hand circuit condenser to give maximum output. Change the resistor to the right-hand circuit and tune the left-hand circuit. If the filter will not tune on exactly 1,000 c/s a lower frequency, say 970 c/s, may be tried.

A constant input of 0.3V is used, as above, the output at the loudspeaker terminals being measured.

The insertion loss of the LF filter is the change in output when the LF filter is switched in, the tone input being at the filter mid-band frequency. The insertion loss should not be more than 3 db.

The bandwidth of the LF filter at 6 db and 20 db below maximum should be 100–150 c/s and 200–400 c/s respectively.

8.5.3 IF Circuit Alignment

Full alignments of the IF circuits which incorporate the crystals is impossible without special CRO apparatus, and should only be undertaken by fully qualified engineers. The alignment oscilloscope type TF.852A (Marconi Instruments Ltd.) has been designed specially for this purpose.

The following instructions therefore apply only to re-alignment of the IF for the 13 kc/s and 8 kc/s pass-band conditions. It is most unlikely that an IF thus re-aligned would give completely satisfactory operation on the crystal controlled pass-bands, i.e., 3 kc/s and 1 kc/s. Adjustments should not therefore be made unless absolutely necessary and should not be undertaken unless the ganging tool, Fig. 6, for locking and adjusting the inductance cores is available.

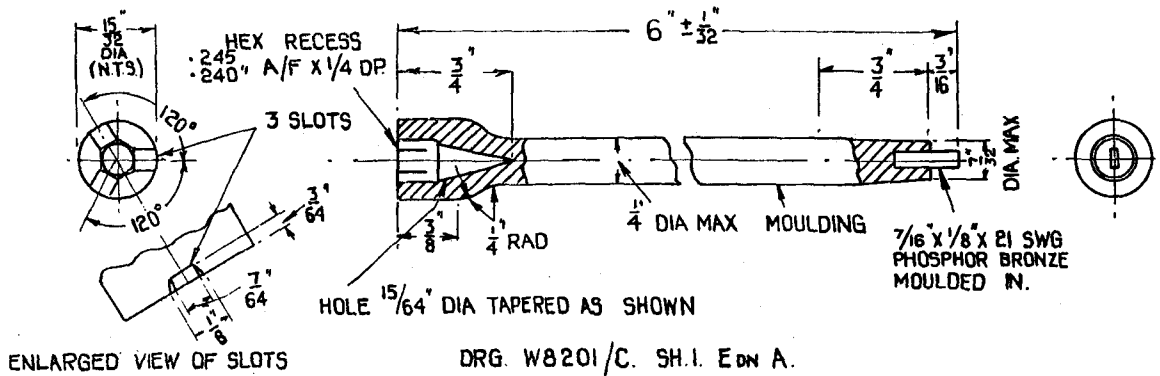

5288

FIG. 6. GANGING TOOL

For IF alignment of the two widest positions of the pass-bands, proceed as follows :—
 Set the operational switch to MOD-MAN, HF GAIN near maximum and pass-band to 8,000 c/s.
 Connect the signal generator to the grid of V5 with the normal connection to the grid of V5 removed and adjust the signal generator to 465 kc/s modulated 40% at 400 c/s.
 Connect the 3-ohm output meter to the LS sockets.
 Tune the inductance cores on the IF2, IF4 and IF6 transformers to give maximum output.
 The 8,000 c/s and 13,000 c/s positions of the pass-band switch for the 465 kc/s IF amplifier should now be in correct alignment.
 Next connect the signal generator to the grid of V3 pin 7 through a 0.1 µF condenser and adjust it to 1,600 kc/s modulated 40% at 400 c/s.
 Set the band-spread condenser to its mid-capacitance position, which should correspond to the knob being in the centre zero position.
 Tune the inductance core in the second oscillator can to give maximum output.
 Tune both cores on the IF1 transformer to give maximum output.
N.B.—It is again emphasised that the above method of aligning only gives correct alignment for the 8,000 c/s and 13,000 c/s pass-band positions.

8.5.4 IF Amplifier Selectivity

The mid-band frequencies of the IF amplifiers are :—

IF1 1,600 kc/s
 IF2 465 c/s

The bandwidths of the IF amplifier chain for the five positions of the selectivity switch at 6 db and 40 db below maximum should be :—

TABLE 15. IF AMPLIFIER SELECTIVITY

| Switch Position | Passband | |
|-----------------|-------------------|-------------------|
| | —6 db | —40 db |
| 100 c/s | 700– 1,100 c/s | 2,500– 5,000 c/s |
| 1,000 c/s | 700– 1,100 c/s | 2,500– 5,000 c/s |
| 3,000 c/s | 2,500– 3,200 c/s | 7,000–10,000 c/s |
| 8,000 c/s | 7,000– 9,000 c/s | 16,000–20,000 c/s |
| 13,000 c/s | 12,500–14,000 c/s | 27,000–33,000 c/s |

8.5.5 465 kc/s Amplifier Sensitivity

Set the HF and LF gain controls at maximum.

Set the operational switch to CW-MAN.

Set the selectivity switch to 8,000 c/s.

The unmodulated input required to give an output of 50 milliwatts into 600 ohms at 465 kc/s is :—

TABLE 16

| Grid of Valve | Input Required |
|---------------|-----------------------|
| V7 | 10,000–40,000 μ V |
| V6 | 300– 1,500 μ V |
| V5 | 30– 150 μ V |

The unmodulated input required at the grid of V5 to give an output of 50 mW for the five positions of the selectivity switch, at the intermediate frequency of 465 kc/s, is :—

TABLE 17

| Switch position | Input to be not more than : |
|-----------------|-----------------------------|
| 100 | 150 μ V |
| 1,000 | 150 μ V |
| 3,000 | 150 μ V |
| 8,000 | 150 μ V |
| 13,000 | 300 μ V |

8.5.6 1.6 Mc/s IF Amplifier Sensitivity

Conditions as for 465 kc/s IF amplifier.

The input to the grid of V5 at 1.6 Mc/s should be between 30 and 150 microvolts.

8.5.7 Second Oscillator Voltage

The RF volts measured between pin 5 of V5 and earth to be $7V \pm 30\%$.

8.5.8 Third Oscillator Voltage

The RF volts measured between pin 3 of V9 and earth, when the anode coil is tuned to give maximum volts, should be $50V \text{ RMS} \pm 30\%$.

N.B.—The anode coil will have to be retuned to give maximum output on the receiver after this test.

8.5.9 RF Circuit Ganging

It is unlikely that any but skilled servicing staff with full laboratory facilities can re-align the highest frequency band (30–60 Mc/s) accurately. The procedure for alignment of other frequency bands is as follows :

Connect the signal generator to the grid of V3 (pin 7) through a 0.1 μ F blocking condenser, adjusted to 2.0 Mc/s.

Set the band-change switch to BAND 1.

Frequency calibration pointer to 2.0 Mc/s.

Pass band to 1,500 c/s.

Operational to CW-MAN.

Use telephone and output meter.

Adjust the core of band 1 oscillator coil L16 until maximum CW output is obtained.

Switch to bands 2, 3 and 4 and adjust L17, L18 and L19 with the signal generator on 4, 8 and 16 Mc/s respectively.

Next tune to the signal generator at 4, 8, 16 and 32 Mc/s on bands 1, 2, 3 and 4. The frequency calibration pointer should then coincide with the calibration marks. If it does not, adjust the penny plate condenser C8 (b) (see Fig. 7) until it does coincide. Do not under any circumstances alter the compensating condenser C8 (a).

Connect the signal generator through a 75-ohm dummy aerial to one aerial socket. Short circuit the second aerial socket.

Switch receiver to BAND 1 and signal generator to 2 Mc/s. Tune in the signal. Adjust the band 1 HF cores in L1, L11 and L6 to give maximum receiver output.

Set the signal generator to 4 Mc/s and tune in at the high-frequency end of band 1. Adjust the capacitance trimmers C13, C23 and C18 to give maximum output. Repeat several times at the top and bottom frequencies until no further improvement in ganging is obtained.

Gang receiver on bands 2 and 3 as above.

For band 4, set the pass-band to 10,000 c/s and take care to retune the receiver oscillator for every adjustment of the trimmers.

8.5.10 First Oscillator Voltage

The RF volts measured across the oscillator section of the ganged condenser to be within $\pm 40\%$ of the figures given in Table 18.

TABLE 18. FIRST OSCILLATOR VOLTAGE

| Band | Frequency, Mc/s | Volts RF |
|------|-----------------|----------|
| 1 | 2 | 20 |
| | 3 | 28 |
| | 4 | 30 |
| 2 | 4 | 17 |
| | 6 | 23 |
| | 8 | 24 |
| 3 | 8 | 17 |
| | 12 | 20 |
| | 16 | 18 |
| 4 | 16 | 11 |
| | 24 | 12 |
| | 32 | 9 |
| 5 | 32 | 4 |
| | 45 | 5 |
| | 60 | 4 |

8.5.11 RF Amplifier Stage Gain

The gain from the aerial to the grid of V1 to be taken with the signal generator connected through 75 ohms to the aerial input terminals.

The other stage gains to be measured from grid to grid of the RF valves.

The HF GAIN control to have its slider connected to earth, so that the gain of the RF valves is kept at a maximum and control is only applied to the IF valves for this test.

The voltage gains given in Table 19 to be within $\pm 30\%$.

TABLE 19. RF AMPLIFIER STAGE GAIN

| Band | Frequency Mc/s | Voltage Gain | | |
|------|-------------------|--------------|-------|-------|
| | | Aerial to V1 | V1-V2 | V2-V3 |
| 1 | 2 | 8 | 3.0 | 4 |
| | 3 | 9 | 1.5 | 5 |
| | 4 | 10 | 0.8 | 10 |
| 2 | 4 | 6 | 5 | 3 |
| | 6 | 7 | 3 | 4 |
| | 8 | 7 | 1.5 | 7 |
| 3 | 8 | 4 | 10 | 6 |
| | 12 | 4 | 6 | 10 |
| | 16 | 4 | 6 | 16 |
| 4 | 16 | 1.5 | 10 | 10 |
| | 24 | 4 | 4 | 10 |
| | 32 | 2 | 4 | 10 |
| 5 | 32 | 1.2 | 3 | 2.5 |
| | 48 | 1.7 | 2 | 4 |
| | 60 | 1.7 | 4 | 3 |

8.5.12 RF Amplifier Selectivity

With the signal generator connected through 75 ohms to the aerial input terminal the image signal protection shall be not less than the figures given in Table 20.

TABLE 20. RF AMPLIFIER SELECTIVITY

| Band | Frequency Mc/s | V2 Grid db | V1 Grid db | Aerial db |
|------|-------------------|---------------|---------------|--------------|
| 1 | 2 | 24 | 58 | 100 |
| | 3 | 24 | 56 | 90 |
| | 4 | 24 | 48 | 80 |
| 2 | 4 | 28 | 62 | 90 |
| | 6 | 28 | 52 | 80 |
| | 8 | 28 | 44 | 70 |
| 3 | 8 | 28 | 50 | 80 |
| | 12 | 26 | 44 | 70 |
| | 16 | 24 | 38 | 65 |
| 4 | 16 | 18 | 48 | 65 |
| | 24 | 14 | 40 | 55 |
| | 32 | 10 | 30 | 40 |
| 5 | 32 | 12 | 30 | 40 |
| | 48 | 10 | 18 | 22 |
| | 60 | 8 | 16 | 20 |

8.5.13 RF Amplifier Detune Ratios

The aerial terminal to be connected to earth through 75 ohms.

The HF GAIN control to be at maximum.

The selectivity switch to be at 8,000 c/s.

The detune ratio of the aerial circuit at any frequency in each band should be within ± 3 db of the figures given in Table 21.

TABLE 21. RF AMPLIFIER DETUNE RATIOS

| Band | Detune |
|------|--------|
| 1 | 9 db |
| 2 | 9 db |
| 3 | 6 db |
| 4 | 5 db |
| 5 | 0 db |

8.5.14 Crystal-controlled First Oscillator Unit

Remove V4 from its valveholder, and plug it into the crystal unit.

Plug in crystal. Move the plug S.19 to the IN position (see Fig. 17).

Set the tuning condenser to a frequency 1.6 Mc/s less than the crystal frequency.

Tune the trimmer condenser C60e on the crystal unit to give maximum sensitivity.

The RF volts measured across the oscillator section of the ganged condenser should be within $\pm 40\%$ of the figures given in Table 22.

TABLE 22. CRYSTAL CONTROLLED OSCILLATOR VOLTS

| Band | Crystal Frequency Range Mc/s | Volts RF |
|------|---------------------------------|----------|
| 1 | 3.6- 5.6 | 13 |
| 2 | 5.6- 9.6 | 11 |
| 3 | 8.6-15.0 | 8.0 |

Above 15.0 Mc/s the second harmonic is selected.

8.5.15 Desensitising

With the desensitising control at maximum and the link removed from the terminal board at the back of the receiver, the sensitivity of the receiver should be at least 120 db less than when the desensitising terminals are connected together.

8.6 Overall Performance

Connect the signal generator to the aerial terminal through 75 ohms.

Set the selectivity switch at 8,000 c/s.

8.6.1 CW Sensitivity

The input required to give 20 db signal to noise ratio should be within 50% to 200% of the figures given in Table 23.

8.6.2 MOD. Sensitivity

With the signal generator modulated 40% at 400 c/s, the input required to give 10 db signal to noise ratio should be within 50% to 200% of the figures given in Table 23.

8.6.3 AGC

The increase in output, when the signal is increased by 60 db above the sensitivity figures given in Table 23, should not be more than 9 db.

8.6.4 Image Protection

The attenuation offered to the image signal should not be less than the figures given in Table 23.

8.6.5

TABLE 23. PERFORMANCE

| Band | Frequency Mc/s | Sensitivity μ V | Image Protection db |
|------|-------------------|------------------------|------------------------|
| 1 | 2 | 1.0 | 100 |
| | 3 | 1.0 | 90 |
| | 4 | 1.0 | 80 |
| 2 | 4 | 1.0 | 90 |
| | 6 | 1.0 | 80 |
| | 8 | 1.0 | 70 |
| 3 | 8 | 1.0 | 80 |
| | 12 | 1.0 | 70 |
| | 16 | 1.0 | 65 |
| 4 | 16 | 2.0 | 65 |
| | 24 | 2.0 | 55 |
| | 32 | 2.0 | 40 |
| 5 | 32 | 7.0 | 40 |
| | 48 | 7.0 | 22 |
| | 60 | 7.0 | 20 |

8.7 Supply Unit

The voltages measured across the output terminals at no load and with the receiver load (HT=65 mA and LT=3.7A) should be as follows :—

TABLE 24. SUPPLY UNIT OUTPUTS

| | No Load | Receiver Load |
|----------|------------------------|------------------------|
| HT Volts | 400 volts DC \pm 10% | 300 volts DC \pm 10% |
| LT Volts | 6.6 volts AC \pm 10% | 6.3 volts AC \pm 10% |

The ripple voltage should not exceed 0.1%.

9. USEFUL AUXILIARY EQUIPMENT

At locations where a number of receivers are installed it is usually desirable to equip the station with a set of instruments for routine performance checks and re-alignment. The following is a brief guide to suitable items for this purpose. The Marconi Instruments Ltd. catalogue gives performance figures of all types manufactured by that Company.

TABLE 25. TEST APPARATUS

| Apparatus | Marconi Instruments Type |
|--------------------------------------|--------------------------|
| Signal Generator 15 kc/s to 30 Mc/s | TF.867 |
| Signal Generator 10 Mc/s to 300 Mc/s | TF.801A |
| Beat Frequency Oscillator | TF.195L |
| Audio Power Meter | TF.340 |
| IF Alignment Oscilloscope | TF.852A |
| Ganging Tool (see Fig. 6) | — |

10. COMPONENTS AND SPARES

10.1 Main Items

The equipment comprises two main items :

| <i>Unit</i> | <i>Type No.</i> | |
|-------------|-----------------|---|
| Receiver | CR.150/3 or 3A | } |
| Supply Unit | 1325/1, 2 or 3 | |
| or | | |
| Supply Unit | 1325/4 or 5 | |

See Table 5

10.2 Accessories (Summary of loose items other than valves).

| <i>Qty.</i> | <i>Description</i> | <i>Identity</i> |
|-------------|--|--------------------|
| 1 | Connector Assembly (Supply Unit to Receiver) | WZ.3956/C Sh.1 |
| 1 | Connector (Supply Unit to Mains) | WIS.3206/C Sh.1 |
| 2 | Plugs (Aerial Input) | W.6015/A, Ref. 72 |
| 1 | Socket (Diversity Oscillator Input) | W.6015/A, Ref. 227 |
| 1 | Socket (465 kc/s Output) | W.6015/A, Ref. 227 |
| 1 | Plug (Loudspeaker Output) | 1/4308/C |
| 1 | Plug (Line Output) | 1/4308/C |

Note : When the equipment is cabinet or rack-mounted the external connections will become part of the cabinet wiring and the above items will cease to exist as loose parts.

10.3 COMPONENTS AND SPARES LIST REF. Y/T.2148/1 No. 1
(Origin Sheet WZ.4157/A)

SPECIAL NOTE

When ordering replacements please state the quantity and quote this list reference and item number thus, where X is the item number :—

Qty.Y/T 2148/1 No. 1/X

HF COMMUNICATIONS RECEIVER
TYPE CR.150/3
DWG. No. W.6015 Sh.1-9
CIRCUIT DIAGRAM No. WZ.4157 Sh.1 (Fig. 17)

| Item No. | Unit No. | Circuit Ref. | Description | Value and Tolerance % | Rating | Sched. No./Ref. |
|------------|----------|--------------|------------------------------|-----------------------|--------|-----------------|
| CAPACITORS | | | | | | |
| 1 | | C1 | 4 Gang Cond. 160 pF Sweep | | | W.6017A/2 |
| 2 | | C2 | | | | |
| 3 | | C3 | | | | |
| 4 | | C4 | | | | |
| 5 | | C5 | Fixed | 5pF ±20 | | W.6017A/30 |
| 6 | | C6 | Fixed | 5pF ±20 | | W.6017A/30 |
| 7 | | C7 | Fixed | 5pF ±20 | | W.6017A/30 |
| 8 | | C8 | Temperature compensator | | | W.6017A/31 |
| 9 | | C9 | Trimmer | 5-25pF | | W.20041/8 |
| 10 | } | Not required | | | | |
| 11 | | | | | | |
| 12 | | | | | | |
| 13 | | | | | | |
| 14 | | | | | | |
| 15 | | C14 | Air Trimmer | 3-30pF | | WSK.13606A/12 |
| 16 | | C15 | Air Trimmer | 3-30pF | | WSK.13606A/13 |
| 17 | | C16 | Air Trimmer | 3-30pF | | WSK.13606A/14 |
| 18 | | C17 | Air Trimmer | 3-30pF | | WSK.13606A/15 |
| 19 | | C18 | Air Trimmer | 3-30pF | | WSK.13606A/16 |

| Item No. | Unit No. | Circuit Ref. | Description | Value and Tolerance % | Rating | Sched. No./Ref. |
|----------|----------|--------------|---------------------|-----------------------|--------|-----------------|
| 20 | | C19 | Air Trimmer | 3-30pF | | WSK.13607A/10 |
| 21 | | C20 | Air Trimmer | 3-30pF | | WSK.13607A/11 |
| 22 | | C21 | Air Trimmer | 3-30pF | | WSK.13607A/12 |
| 23 | | C22 | Air Trimmer | 3-30pF | | WSK.13607A/13 |
| 24 | | C23 | Air Trimmer | 3-30pF | | WSK.13607A/14 |
| 25 | | C24 | Ceramic | 20pF \pm 2pF | | WSK.13605A/17 |
| 26 | | C25 | Ceramic | 20pF \pm 2pF | | WSK.13606A/17 |
| 27 | | C26 | Ceramic | 30pF \pm 3pF | | WSK.13607A/15 |
| 28 | | C27 | Tubular Metal Paper | .002 μ F | | WSK.13605A/18 |
| 29 | | C28 | Tubular Metal Paper | .01 μ F | | WSK.13605A/19 |
| 30 | | C29 | Tubular Metal Paper | .01 μ F | | WSK.13502A/19 |
| 31 | | C30 | Tubular Metal Paper | .01 μ F \pm 20 | | W.6017A/32 |
| 32 | | C31 | Tubular Metal Paper | .002 μ F | | WSK.13606A/18 |
| 33 | | C32 | Tubular Metal Paper | .01 μ F | | WSK.13606A/19 |
| 34 | | C33 | Tubular Metal Paper | .01 μ F | | WSK.13502A/20 |
| 35 | | C34 | Tubular Metal Paper | .01 μ F \pm 20 | | W.6017A/32 |
| 36 | | C35 | Tubular Metal Paper | .002 μ F | | WSK.13607A/17 |
| 37 | | C36 | Tubular Metal Paper | .01 μ F | | WSK.13607A/19 |
| 38 | | C37 | Ceramic | 10pF \pm 10 | | WSK.13607A/16 |
| 39 | | C38 | Ceramic | 10pF \pm 10 | | WSK.13607A/20 |
| 40 | | C39 | Ceramic | 100pF | | WSK.13607A/21 |
| 41 | | C40 | Ceramic | 500pF | | WSK.13607A/22 |
| 42 | | C41 | Tubular Metal Paper | .002 μ F | | WSK.13607A/18 |
| 43 | | C42 | Tubular Metal Paper | .01 μ F \pm 20 | | W.6017A/32 |
| 44 | | C43 | Tubular Metal Paper | .01 μ F \pm 20 | | WSK.13502A/21 |
| 45 | | C44 | Ceramic | 10pF \pm 10 | | WSK.13608A/18 |
| 46 | | C45 | Tubular Metal Paper | 0.1 μ F | | WSK.13502A/23 |
| 47 | | C46 | Stacked Mica | 500pF | | WSK.13502A/22 |
| 48 | | C47 | Ceramic | 100pF \pm 20 | | W.6017A/35 |
| 49 | | C48 | Stacked Mica | 1700pF \pm 15 | | WSK.13608A/14 |
| 50 | | C49 | Stacked Mica | 890pF \pm 10 | | WSK.13608A/15 |
| 51 | | C50 | Stacked Mica | 480pF \pm 5 | | WSK.13608A/16 |
| 52 | | C51 | Ceramic | 5pF \pm 20 | | WSK.13608A/19 |
| 53 | | C52 | Stacked Mica | 263pF \pm 5 | | WSK.13608A/17 |
| 54 | | C53 | Ceramic | 100pF \pm 10 | | WSK.13608A/20 |
| 55 | | C54 | Ceramic | 100pF \pm 10 | | WSK.13608A/21 |
| 56 | | C55 | Ceramic | 1pF \pm 0.5pF | | W.6017A/36 |
| 57 | | C56 | Air Trimmer | 3-30pF | | WSK.13730A/10 |
| 58 | | C57 | Ceramic | 5pF \pm 20 | | W.6017A/30 |
| 59 | | | Not required | | | |

| Item No. | Unit No. | Circuit Ref. | Description | Value and Tolerance % | Rating | Sched. No./Ref. |
|----------|----------|--------------|---------------------|-----------------------|--------|-----------------|
| 60 | | C59 | Ceramic | 100pF \pm 5 | | WSK.13292A/13 |
| 61 | | C60 | Ceramic | 100pF \pm 5 | | WSK.13292A/12 |
| 62 | | C60a | Tubular Metal Paper | 0.1 μ F \pm 20 | | W.20041/11 |
| 63 | | C60b | Tubular Metal Paper | 0.1 μ F \pm 20 | | W.20041/11 |
| 64 | | C60c | Tubular Metal Paper | .01 μ F | | W.20041/12 |
| 65 | | C60d | Ceramic | 47pF \pm 5 | | W.20041/13 |
| 66 | | C60e | Air Trimmer | 2.4-30pF | | W.20041/9 |
| 67 | | C60f | Ceramic | 100pF \pm 5 | | W.20041/14 |
| 68 | | C60g | Ceramic | 15pF \pm 10 | | W.20041/15 |
| 69 | | C61 | Stacked Mica | 2000pF \pm 5 | | WSK.13160A/17 |
| 70 | | C62 | Air Trimmer | 10pF | | WSK.13160A/10 |
| 71 | | C63 | Stacked Mica | 500pF \pm 5 | | WSK.13160A/15 |
| 72 | | C64 | Ceramic | 100pF \pm 5 | | WSK.13160A/16 |
| 73 | | C65 | Ceramic | 220pF \pm 5 | | W.16193B/11 |
| 74 | | C66 | Ceramic | 180pF \pm 5 | | W.16193B/10 |
| 75 | | C67 | Ceramic | 47pF \pm 5 | | W.20048B/15 |
| 76 | | C68 | Ceramic | 220pF \pm 5 | | W.16193B/11 |
| 77 | | C69 | Ceramic | 180pF \pm 5 | | W.16193/10 |
| 78 | | C70 | Ceramic | 47pF \pm 5 | | W.20048B/15 |
| 79 | | C71 | Ceramic | 180pF \pm 5 | | W.20048B/10 |
| 80 | | C72 | Ceramic | 220pF \pm 5 | | W.20048B/11 |
| 81 | | C73 | Trimmer | 10pF | | W.13161A/8 |
| 82 | | C74 | Ceramic | 420pF \pm 5 | | W.13161A/12 |
| 83 | | C75 | Ceramic | 2000pF \pm 5 | | W.13161A/13 |
| 84 | | C76 | Ceramic | 100pF \pm 5 | | W.13161A/14 |
| 85 | | C77 | Ceramic | 200pF \pm 5 | | WSK.13289A/16 |
| 86 | | Not required | | | | |
| 87 | | C79 | Ceramic | 1000pF \pm 5 | | WSK.13289A/17 |
| 88 | | C80 | Stacked Mica | 3100pF \pm 2 | | W.13673C/3 |
| 89 | | C81 | Air Trimmer | 1450-2000pF | | W.8133/4 |
| 90 | | C82 | Air Trimmer | 1450-2000pF | | W.8133/4 |
| 91 | | C83 | Ceramic | 3100pF \pm 2 | | W.13673C/3 |
| 92 | | C84 | Tubular Metal Paper | .02 μ F | | W.6015A/83 |
| 93 | | C85 | Tubular Metal Paper | 0.1 μ F \pm 20 | | W.20040/2 |
| 94 | | C86 | Tubular Metal Paper | 0.1 μ F \pm 20 | | W.20040/2 |
| 95 | | C87 | Tubular Metal Paper | 0.1 μ F \pm 20 | | W.20040/2 |
| 96 | | C88 | Tubular Metal Paper | .02 μ F | | W.6015A/83 |
| 97 | | C89 | Air Trimmer | 3-30pF | | W.20040/3 |
| 98 | | C90 | Ceramic | 20pF \pm 5 | | W.20040/15 |
| 99 | | C91 | Tubular Metal Paper | 0.1 μ F \pm 20 | | W.20040/2 |

| Item No. | Unit No. | Circuit Ref. | Description | Value and Tolerance % | Rating | Sched. No./Ref. |
|----------|----------|--------------|---------------------|--|--------|-----------------|
| 100 | | C92 | Tubular Metal Paper | 0.1 μ F \pm 20 | | W.20040/2 |
| 101 | | C93 | Tubular Metal Paper | 0.1 μ F \pm 20 | | W.20040/2 |
| 102 | | Not required | | | | |
| 103 | | C95 | Air Trimmer | 3-30pF | | W.20040/3 |
| 104 | | C96 | Ceramic | 20pF | | W.20040/15 |
| 105 | | C97 | Ceramic | 470pF \pm 5 | | W.6015A/240 |
| 106 | | C98 | Tubular Paper | 0.1 μ F \pm 20 | | W.20034B/5 |
| 107 | | C99 | Tubular Paper | 0.1 μ F \pm 20 | | W.20039B/5 |
| 108 | | C100 | Tubular Paper | 0.1 μ F \pm 20 | | W.20039B/5 |
| 109 | | C101 | Tubular Paper | 2pF \pm 20 | | W.6015A/87 |
| 110 | | C102 | Tubular Paper | 0.1 μ F \pm 20 | | W.6015A/82 |
| 111 | | C103 | Tubular Paper | 0.1 μ F \pm 20 | | W.6015A/82 |
| 112 | | C104 | Tubular Paper | 0.1 μ F \pm 20 | | W.20038C/3 |
| 113 | | C105 | Ceramic | 100pF \pm 20 | | W.6015A/88 |
| 114 | | C106 | Ceramic | 100pF \pm 20 | | W.20039B/6 |
| 115 | | C107 | Tubular Paper | .01 μ F | | W.6015A/84 |
| 116 | | C108 | Ceramic | 100pF \pm 20 | | W.20039B/6 |
| 117 | | C109 | Ceramic | 100pF \pm 20 | | W.20039B/6 |
| 118 | | C110 | Tubular Paper | .02 μ F | | W.6015A/83 |
| 119 | | C111 | Tubular Paper | 1μF ^{250F 25V} EL2C7 | | W.6015A/80 |
| 120 | | C112 | Tubular Paper | .02 μ F | | W.6015A/83 |
| 121 | | C113 | Tubular Paper | 1 μ F | | W.6015A/80 |
| 122 | | C114 | Tubular Paper | .01 μ F | | W.6015A/84 |
| 123 | | C115 | Tubular Paper | 0.1 μ F \pm 20 | | W.6015A/82 |
| 124 | | C116 | Tubular Paper | 0.5 μ F | | W.6015A/89 |
| 125 | | C117 | Ceramic | 100pF \pm 20 | | W.20039B/6 |
| 126 | | C118 | Tubular Paper | 0.1 μ F | | W.6015A/85 |
| 127 | | C119 | Tubular Paper | 0.1 μ F | | W.6015A/85 |
| 128 | | C120 | Stacked Mica | 500pF | | W.6015A/90 |
| 129 | | Not required | | | | |
| 130 | | C122 | Electrolytic | 25 μ F-20 +100 | | W.20038B/2 |
| 131 | | C123 | Tubular Paper | 0.1 μ F \pm 20 | | W.20040/2 |
| 132 | | C124 | Tubular Paper | 0.1 μ F \pm 20 | | W.20040/2 |
| 133 | | C125 | Tubular Paper | 0.1 μ F \pm 20 | | W.20040/2 |
| 134 | | C126 | Tubular Paper | 0.001 μ F | | W.6015A/74 |
| 135 | | C127 | Ceramic | 6.8pF \pm 10 | | W.20048B/16 |
| 136 | | C128 | Trimmer | 2-8pF | | W.20048B/3 |
| 137 | | C124 | Ceramic | 6.8pF \pm 10 | | W.20048B/16 |
| 138 | | C130 | Trimmer | 2-8pF | | W.20048B/3 |
| 139 | } | Not required | | | | |
| 140 | | | | | | |
| 141 | | | | | | |
| 142 | | | | | | |
| 143 | | | | | | |
| 144 | | | | | | |
| 145 | | | | | | |

| Item No. | Unit No. | Circuit Ref. | Description | Value and Tolerance % | Rating | Sched. No./Ref. |
|------------------|----------|--------------|-------------------|-----------------------|--------|-----------------|
| RESISTORS | | | | | | |
| 146 | | R1 | Carbon | 47k $\Omega \pm 20$ | | WSK.13502A/2 |
| 147 | | R2 | Carbon | 47k $\Omega \pm 20$ | | WSK.13502A/3 |
| 148 | | R3 | Ceramic Metalised | 10 $\Omega \pm 20$ | | WSK.13605A/20 |
| 149 | | R4 | Carbon | 220 $\Omega \pm 20$ | | WSK.13502A/4 |
| 150 | | R5 | Carbon | 47 $\Omega \pm 20$ | | WSK.13502A/5 |
| 151 | | R6 | Carbon | 47 $\Omega \pm 20$ | | WSK.13607A/33 |
| 152 | | R7 | Carbon | 10k $\Omega \pm 20$ | | WSK.13502A/6 |
| 153 | | R8 | Carbon | 10k $\Omega \pm 20$ | | WSK.13502A/7 |
| 154 | | R9 | Carbon | 100k $\Omega \pm 20$ | | WSK.13502A/8 |
| 155 | | R10 | Ceramic Metalised | 10 $\Omega \pm 20$ | | W.6017A/40 |
| 156 | | R11 | Carbon | 220 $\Omega \pm 20$ | | WSK.13502A/9 |
| 157 | | R12 | Carbon | 47k $\Omega \pm 20$ | | WSK.13502A/10 |
| 158 | | R13 | Carbon | 10k $\Omega \pm 20$ | | WSK.13502A/11 |
| 159 | | R14 | Carbon | 10k $\Omega \pm 20$ | | WSK.13502A/12 |
| 160 | | R15 | Carbon | 100 $\Omega \pm 20$ | | WSK.13502A/13 |
| 161 | | R16 | Carbon | 3.3k $\Omega \pm 20$ | | WSK.13502A/14 |
| 162 | | R17 | Carbon | 10k $\Omega \pm 20$ | | WSK.13502A/15 |
| 163 | | R18 | Carbon | 10k $\Omega \pm 20$ | | WSK.13502A/17 |
| 164 | | R19 | Carbon | 22 $\Omega \pm 20$ | | WSK.13608A/10 |
| 165 | | R20 | Carbon | 10k $\Omega \pm 20$ | | W.6017A/42 |
| 166 | | R21 | Carbon | 10k $\Omega \pm 20$ | | WSK.13502A/18 |
| 167 | | R22 | Carbon | 1k $\Omega \pm 20$ | | WSK.13502A/16 |
| 168 | | R23 | Carbon | 100k $\Omega \pm 20$ | | W.6017A/43 |
| 169 | | R24 | Carbon | 10k $\Omega \pm 20$ | | WSK.13607A/23 |
| 170 | | R25 | Carbon | 10k $\Omega \pm 20$ | | WSK.13607A/23 |
| 171 | | R26 | Carbon | 47k $\Omega \pm 20$ | | WSK.13502A/2 |
| 172 | | R26a | Carbon | 47k $\Omega \pm 20$ | | W.20041/19 |
| 173 | | R26b | Carbon | 33k $\Omega \pm 20$ | | W.20041/18 |
| 174 | | R26c | Carbon | 10k $\Omega \pm 20$ | | W.20041/17 |
| 175 | | R26d | Carbon | 180 $\Omega \pm 20$ | | W.20041/16 |
| 176 | | R26e | Carbon | 47k $\Omega \pm 20$ | | W.20041/19 |
| 177 | | R27 | Carbon | 33k $\Omega \pm 20$ | | W.20041/12 |
| 178 | | R28 | Carbon | 330 $\Omega \pm 20$ | | W.20041/13 |
| 179 | | R29 | Carbon | 100k $\Omega \pm 20$ | | W.20040/14 |
| 180 | | R30 | Carbon | 10k $\Omega \pm 20$ | | W.20040/6 |
| 181 | | R31 | Carbon | 47k $\Omega \pm 20$ | | W.20040/10 |
| 182 | | R32 | Carbon | 150k $\Omega \pm 20$ | | W.20040/4 |
| 183 | | R33 | Carbon | 1k $\Omega \pm 20$ | | W.20040/5 |
| 184 | | R34 | Carbon | 1k $\Omega \pm 20$ | | W.20040/5 |
| 185 | | R35 | Carbon | 1k $\Omega \pm 20$ | | W.20040/5 |

| Item No. | Unit No. | Circuit Ref. | Description | Value and Tolerance % | Rating | Sched. No./Ref. |
|----------|----------|--------------|-------------|-----------------------|--------|-----------------|
| 186 | | R36 | Carbon | 47k $\Omega \pm 20$ | | W.20040/10 |
| 187 | | R37 | Carbon | 2.2k $\Omega \pm 20$ | | W.6015A/57 |
| 188 | | R38 | Carbon | 220k $\Omega \pm 20$ | | W.6015A/53 |
| 189 | | R39 | Carbon | 10k $\Omega \pm 20$ | | W.20040/6 |
| 190 | | R40 | Carbon | 470 $\Omega \pm 20$ | | W.20040/7 |
| 191 | | R41 | Carbon | 2.2k $\Omega \pm 20$ | | W.20038C/4 |
| 192 | | R42 | Carbon | 100k $\Omega \pm 20$ | | W.20034B/11 |
| 193 | | R43 | Carbon | 22k $\Omega \pm 20$ | | W.20039B/7 |
| 194 | | R44 | Carbon | 10k $\Omega \pm 20$ | | W.20039B/9 |
| 195 | | R45 | Carbon | 1k $\Omega \pm 20$ | | W.20039B/10 |
| 196 | | R46 | Carbon | 470k $\Omega \pm 20$ | | W.20040/8 |
| 197 | | R47 | Carbon | 2.2M $\Omega \pm 20$ | | W.20040/9 |
| 198 | | R48 | Carbon | 47k $\Omega \pm 20$ | | W.20039B/8 |
| 199 | | R49 | Carbon | 22k $\Omega \pm 20$ | | W.20039B/7 |
| 200 | | R50 | Carbon | 1M $\Omega \pm 20$ | | W.20039B/12 |
| 201 | | R51 | Carbon | 2.2M $\Omega \pm 20$ | | W.6015A/51A |
| 202 | | R52 | Carbon | 220k $\Omega \pm 20$ | | W.16199B/12 |
| 203 | | R53 | Carbon | 1k $\Omega \pm 20$ | | W.6015A/58 |
| 204 | | R54 | Carbon | 330k $\Omega \pm 20$ | | W.16199B/11 |
| 205 | | R55 | Carbon | 150k $\Omega \pm 20$ | | W.6015A/54 |
| 206 | | R56 | Carbon | 5k $\Omega \pm 20$ | | W.6015A/70 |
| 207 | | R57 | Carbon | 470k $\Omega \pm 20$ | | W.6015A/52 |
| 208 | | R58 | Carbon | 47k $\Omega \pm 20$ | | W.6015A/55 |
| 209 | | R59 | Carbon | 120 $\Omega \pm 20$ | | W.6015A/127 |
| 210 | | Not required | | | | |
| 211 | | R61 | Wire Wound | 82 $\Omega \pm 5$ | | W.20055C/2 |
| 212 | | R62 | Wire Wound | 96 $\Omega \pm 5$ | | W.20055C/3 |
| 213 | | R63 | Wire Wound | 96 $\Omega \pm 5$ | | W.20055C/3 |
| 214 | | R64 | Wire Wound | 179 $\Omega \pm 5$ | | W.20055C/4 |
| 215 | | R65 | Wire Wound | 56 $\Omega \pm 5$ | | W.20055C/5 |
| 216 | | R66 | Carbon | 470 $\Omega \pm 5$ | | W.20055C/6 |
| 217 | | R67 | Carbon | 2.2k $\Omega \pm 5$ | | W.20055C/7 |
| 218 | | R69 | Carbon | 167 $\Omega \pm 5$ | | W.20055C/8 |
| 219 | | R68 | Wire Wound | 40 $\Omega \pm 5$ | | W.20055C/9 |
| 220 | | R70 | Wire Wound | 250 $\Omega \pm 5$ | | W.20055C/10 |
| 221 | | R71 | Carbon | 470 $\Omega \pm 5$ | | W.6015A/66 |
| 222 | | R72 | Carbon | 150k $\Omega \pm 20$ | | W.20039B/13 |
| 223 | | R73 | Carbon | 100k $\Omega \pm 20$ | | WSK.13160A/18 |
| 224 | | R74 | Carbon | 100k $\Omega \pm 20$ | | WSK.13161A/16 |
| 225 | | R75 | Carbon | 10k $\Omega \pm 20$ | | WSK.13161A/15 |

| Item No. | Unit No. | Circuit Ref. | Description | Value and Tolerance % | Rating | Sched. No./Ref. |
|---------------------|----------|--------------|--------------|-----------------------|--------|-----------------|
| 226 | | R76 | Carbon | 22k $\Omega \pm 20$ | | WSK.13289A/19 |
| 227 | | R77 | Carbon | 100k $\Omega \pm 20$ | | WSK.13289A/20 |
| 228 | | R78 | Carbon | 4.7k $\Omega \pm 20$ | | W.6015A/51 |
| 229 | | R79 | Carbon | 470k $\Omega \pm 20$ | | W.20040/8 |
| 230 | | R80 | Carbon | 1M $\Omega \pm 20$ | | W.6015A/68 |
| 231 | | R81 | Wire Wound | 10 $\Omega \pm 20$ | | W.6015A/238 |
| 232 | | R82 | Wire Wound | 10 $\Omega \pm 20$ | | W.6015A/238 |
| 233 | | Not required | | | | |
| 234 | | R84 | Carbon | 470k $\Omega \pm 20$ | | W.6015A/52 |
| 235 | } | Not required | | | | |
| 236 | | | | | | |
| 237 | | | | | | |
| 238 | | | | | | |
| TRANSFORMERS | | | | | | |
| 239 | | T1 | Output | | | W.6015A/210 |
| 240 | } | Not required | | | | |
| 241 | | | | | | |
| 242 | | | | | | |
| 243 | | | | | | |
| INDUCTORS | | | | | | |
| 247 | | L1 | RF Coil | | | WSK.13605A/6 |
| 248 | | L2 | RF Coil | | | WSK.13605A/7 |
| 249 | | L3 | RF Coil | | | WSK.13605A/8 |
| 250 | | L4 | RF Coil | | | WSK.13605A/9 |
| 251 | | L5 | RF Coil | | | WSK.13605A/11 |
| 252 | | L6 | RF Coil | | | WSK.13606A/6 |
| 253 | | L7 | RF Coil | | | WSK.13606A/7 |
| 254 | | L8 | RF Coil | | | WSK.13606A/8 |
| 255 | | L9 | RF Coil | | | WSK.13606A/9 |
| 256 | | L10 | RF Coil | | | WSK.13606A/11 |
| 257 | | L11 | RF Coil | | | WSK.13607A/4 |
| 258 | | L12 | RF Coil | | | WSK.13607A/5 |
| 259 | | L13 | RF Coil | | | WSK.13607A/6 |
| 260 | | L14 | RF Coil | | | WSK.13607A/8 |
| 261 | | L15 | RF Coil | | | WSK.13607A/9A |
| 262 | | L16 | RF Coil Osc. | | | WSK.13608A/4 |
| 263 | | L17 | RF Coil Osc. | | | WSK.13608A/5 |
| 264 | | L18 | RF Coil Osc. | | | WSK.13608A/6 |
| 265 | | L19 | RF Coil Osc. | | | WSK.13608A/7 |
| 266 | | L20 | RF Coil Osc. | | | WSK.13608A/9 |

| Item No. | Unit No. | Circuit Ref. | Description | Value and Tolerance % | Rating | Sched. No./Ref. |
|----------------|----------|--------------|-------------------------|-----------------------|--------|-----------------|
| 267 | | L21 | IF Coil | | | WSK.13292A/11 |
| 268 | | L22 | IF Coil | | | WSK.13292A/10 |
| 269 | | L23 | RF Coil Osc. | | | WSK.13160A/14 |
| 270 | | L24 | IF Coil | | | W.16193B/2 |
| 271 | | L25 | IF Coil | | | W.16193B/1 |
| 272 | | L26 | IF Coil | | | W.20048B/1 |
| 273 | | L27 | IF Coil | | | W.16193B/2 |
| 274 | | L28 | IF Coil | | | W.16193B/1 |
| 275 | | L29 | IF Coil | | | W.20048B/1 |
| 276 | | L30 | IF Coil | | | W.16199B/2 |
| 277 | | L31 | IF Coil | | | W.16199B/1 |
| 278 | | L32 | Osc. Coil | | | WSK.13161A/18 |
| 279 | | L33 | AF Coil | | | W.6015A/212 |
| 280 | | L34 | AF Coil | | | WSK.13289A/10 |
| 281 | | L35 | AF Coil | | | W.8133/2 |
| 282 | | L36 | AF Coil | | | W.8133/3 |
| 283 | | Not required | | | | |
| 284 | | | | | | |
| | | | | | | |
| POTENTIOMETERS | | | | | | |
| 285 | | P1 | TCT Linear Law | 2k Ω METEX | | W.6015A/76 |
| 286 | | P2 | Double TCT Linear Law | 1M Ω AF GAIN | | W.6015A/101 |
| | | P3 | Two Gang Inverse Law | 2k Ω RF GAIN | | W.6015A/78 |
| 287 | | and | | | | |
| | | P4 | TCT Straight Law | 5k Ω IF GAIN | | W.6015A/78 |
| 288 | | P5 | TCT Straight Law | 5k Ω DESENSE | | W.6015A/126 |
| 289 | | Not required | | | | |
| 290 | | | | | | |
| 291 | | | | | | |
| 292 | | | | | | |
| | | | | | | |
| SWITCHES | | | | | | |
| 293 | | S1-S2 | Band Change Aerial Unit | | | WSK.13607A/3 |
| 294 | | S3 | Band Change Mixing Unit | | | WSK.13606A/3 |
| 295 | | S4-S5 | Band Change HF Unit | | | WSK.13607A/2 |
| 296 | | S6-S7 | Band Change Osc. Unit | | | WSK.13608A/2 |
| 297 | | S8-S12 | Pass Band | | | W.6015A/24 |
| 298 | | S13-S14 | Operational | | | W.6015A/120 |
| 299 | | S15-S16 | Metering | | | W.6015A/30 |
| 300 | | S17 | Mains | | | W.6015A/31 |
| 301 | | S18 | Selector Plate and Plug | | | W.6015A/93 |
| 302 | | S19 | Selector Plate and Plug | | | W.20041/22 |

| Item No. | Unit No. | Circuit Ref. | Description | Value and Tolerance % | Rating | Sched. No./Ref. |
|----------------------|----------|--------------|-----------------|-----------------------|--------|-----------------|
| 303 | | | | | | |
| 304 | | | | | | |
| 305 | | | | | | |
| 306 | | | | | | |
| 307 | | | | | | |
| 308 | | | | | | |
| 309 | | | Not required | | | |
| 310 | | | | | | |
| 311 | | | | | | |
| 312 | | | | | | |
| 313 | | | | | | |
| 314 | | | | | | |
| VALVES | | | | | | |
| 315 | V1 | | EF 50 | | | |
| 316 | V2 | | EF 50 | | | |
| 317 | V3 | | EF 50 | | | |
| 318 | V4 | | EF 50 | | | |
| 319 | V5 | | X66 | | | |
| 320 | V6 | | 6K7G | | | |
| 321 | V7 | | 6K7G | | | |
| 322 | V8 | | DH63 | | | |
| 323 | V9 | | 6K7G | | | |
| 324 | V10 | | DH63 | | | |
| 325 | V11 | | L63 | | | |
| 326 | V12 | | STV280/40 | | | |
| VALVE HOLDERS | | | | | | |
| 327 | | | For V1-V4 | 9-pin | | WIS.2979/2 |
| 328 | | | For V5-V11 | 8-pin | | W.6015A/40 |
| 329 | | | For V12 | 4-pin | | W.6015A/41 |
| 330 | | | Screening Cover | | | W.6015A/73 |
| 331 | | | | | | |
| 332 | | | Not required | | | |
| 333 | | | | | | |
| IF UNITS | | | | | | |
| 334 | IF1 | | Complete Unit | | | W.6017A/5 |
| 335 | IF2 | | Complete Unit | | | W.6015A/204 |
| 336 | IF3 | | Complete Unit | | | W.6015A/119 |
| 337 | IF4 | | Complete Unit | | | W.6015A/206 |
| 338 | IF5 | | Complete Unit | | | W.6015A/218 |

| Item No. | Unit No. | Circuit Ref. | Description | Value and Tolerance % | Rating | Sched. No./Ref. |
|----------|----------|--------------|---|-----------------------|--------|-----------------|
| 339 | | IF6 | Complete Unit | | | W.6015A/208 |
| 340 | | | Not required | | | |
| 341 | | 2nd Osc. | Complete Unit | | | W.6015A/10 |
| 342 | | 3rd Osc. | Complete Unit | | | W.6015A/11 |
| 343 | | Calibrator | Complete Unit | | | W.6015A/209 |
| 344 | | LF Filter | Complete Unit | | | W.6015A/241 |
| 345 | | | Not required | | | |
| 346 | | | | | | |
| 347 | | | | | | |
| | | | | | | |
| | | | CHOKES | | | |
| 348 | | CH1 | AGC Circuit | | | W.6015A/170 |
| 349 | | CH2 | 3rd Osc. Heater Circuit | | | W.20039B/16 |
| 350 | | CH3 | Calibrator Circuit | | | WSK.13289A/14 |
| 351 | | | Not required | | | |
| 352 | | | | | | |
| | | | METERS | | | |
| 353 | | M1 | Milliammeter | 0-10mA | | W.6015A/28 |
| 354 | | | Not required | | | |
| | | | CRYSTALS | | | |
| 355 | | CRY-1 | Guard Frequency (state frequency required) | | | |
| 356 | | X1-X2 | For IF3 Filter | | | W.20048B/9 |
| 357 | | X3-X4 | For IF5 Filter | | | W.20048B/8 |
| 358 | | X5 | Calibrator | | | WSK.13289A/12 |
| 359 | | | Crystal holder for X1-X2, and X3-X4 | | | W.20048B/2 |
| 360 | | | Crystal holder for X5 | | | WSK.13346 |
| 361 | | | Not required | | | |
| | | | LAMPS | | | |
| 362 | | IL1 | Illuminating Lamp | 8V | 1.6W | W.6015A/143 |
| 363 | | IL2 | Illuminating Lamp | 8V | 1.6W | W.6015A/143 |
| 364 | | | Lampholder for IL1 and IL2 | | | W.6015A/144 |
| | | | JACKS | | | |
| 365 | | J1 and J2 | Jack Strip | | | W.6015A/36 |
| 366 | | | Not required | | | |
| 367 | | | | | | |
| 368 | | | | | | |
| | | | | | | |

| Item No. | Unit No. | Circuit Ref. | Description | Value and Tolerance % | Rating | Sched. No./Ref. |
|----------------------|----------|--------------|---|-------------------------|--------|-----------------|
| MISCELLANEOUS | | | | | | |
| 369 | | | Case for set | | | W.6015A/114 |
| 370 | | | Front Panel | | | W.6015A/115 |
| 371 | | | Side Plate (LH) | | | W.6015A/194 |
| 372 | | | Side Plate (RH) | | | W.6015A/195 |
| 373 | | | Chassis | | | W.6015A/118 |
| 374 | | | Feet | | | W.6015A/146 |
| 375 | | | Mounting Plate | | | |
| | | | 1 $\frac{5}{8}$ in. \times 3 $\frac{3}{8}$ in. \times 14SWG | | | W.6015A/121 |
| 376 | | | Bearing Plate | | | |
| | | | 1 in. \times $\frac{5}{8}$ in. \times $\frac{1}{8}$ in. | | | W.6015A/21 |
| 377 | | Not required | | | | |
| 378 | | | Long Escutcheon | } For calibration scale | | W.6015A/6 |
| 379 | | | Long Window | | | W.6015A/7 |
| 380 | | Not required | | | | |
| 381 | | | Round Escutcheon | } For logging scale | | W.6015A/4 |
| 382 | | | Round Window | | | W.6015A/5 |
| 383 | | | Control knob for C1-C4 (large) | | | W.6015A/97 |
| 384 | | | Control knob for C1-C4 (small) | | | W.6015A/98 |
| 385 | | | Control knob for C9 | | | W.6015A/95 |
| 386 | | | Control knob for C62 | | | W.6015A/95 |
| 387 | | | Control knob for P2 | | | W.6015A/96 |
| 388 | | | Control knob for P3 & P4 | | | W.6015A/95 |
| 389 | | | Cover for P5 | | | W.6015A/125 |
| 390 | | | Control knob for S1-S7 | | | W.6015A/96 |
| 391 | | | Control knob for S8-S12 | | | W.6015A/96 |
| 392 | | | Control knob for S13-S14 | | | W.6015A/96 |
| 393 | | | Control knob for S15-S16 | | | W.6015A/95 |
| 394 | | Not required | | | | |
| 395 | | | Plugs, mains, 5-way | | | W.6015A/37 |
| 396 | | | Plug and socket, line, 2-way | | | W.6015A/35 |
| 397 | | | Plug and socket, LS, 2-way | | | W.6015A/25 |
| 398 | | | Plug, coaxial, aerial input | | | W.6015A/72 |
| 399 | | | Socket, coaxial, aerial input | | | W.6015A/71 |
| 400 | | | Plug, coaxial, 465 kc/s output | | | W.6015A/226 |
| 401 | | | Socket, coaxial, 465 kc/s output | | | W.6015A/227 |
| 402 | | | Connector (to supply unit) | | | WZ.3956/C Sh.1 |
| 403 | | Not required | | | | |
| 404 | | | Resistance board, Fig. 9a | | | W.6015A/122 |
| 405 | | | Resistance board, Fig. 9b | | | W.6015A/128 |
| 406 | | | Resistance board, Fig. 9c | | | W.6017A/34 |
| 407 | | | Resistance board, Fig. 9d | | | W.6015A/123 |
| 408 | | Not required | | | | |
| 409 | | | Tag, 4BA for items 300 & 329 | | | W.6015A/131 |
| 410 | | | Tag, 6BA | | | W.6015A/139 |

10.4 COMPONENTS AND SPARES LIST REF. : Y/T.2148/1 No. 2
 (Origin Sheet WZ.3951/A)

SPECIAL NOTE

When ordering replacements please state the quantity and quote this list reference and item number thus, where X is the item number :—

Qty.....Y/T 2148/1 No. 2/X

SUPPLY UNIT FOR RECEIVER CR.150/3
TYPE 1325/1, 2 and 3
 DWG. No W.20050 Sh. 1
 CIRCUIT DIAGRAM No. WZ.3951/B. Sh. 1. (Fig. 18a)

| Item No. | Unit No. | Circuit Ref. | Description | Value and Tolerance % | Rating | Sched. No./Ref. |
|-------------------|--------------|--------------|-----------------------------|-----------------------|--------|-----------------|
| CAPACITORS | | | | | | |
| 1 | C1 | | Electrolytic | 8 μ F—20 +50 | 450V | W.20050A/19 |
| 2 | C2 | | Electrolytic | 8 μ F—20 +50 | | W.20050A/19 |
| 3 | C3 | | Electrolytic | 8 μ F—20 +50 | | W.20050A/19 |
| 4 } 5 } | Not required | | | | | |
| FUSES | | | | | | |
| 6 | F1 | | Cartridge | 2A | | W.20050A/37 |
| 7 | F2 | | Cartridge | 2A | | W.20050A/37 |
| 8 | F3 | | Cartridge | 500mA | | W.20050A/17 |
| 9 | | | Fuseholder for (F1, F2, F3) | | | W.20050A/8 |
| 10 | Not required | | | | | |

| Item No. | Unit No. | Circuit Ref. | Description | Value and Tolerance % | Rating | Sched. No./Ref. |
|--------------------------------|----------|--------------|------------------------------|-----------------------|--------|-----------------|
| CHOKES AND TRANSFORMERS | | | | | | |
| 11 | CH1 | | Choke, Iron Core | 15-20H | | W.20050A/10 |
| 12 | CH2 | | Choke, Iron Core | 15-20H | | W.20050A/10 |
| 13 | T1 | | Mains Transformer | | | W.20050A/9 |
| 14 } 15 } | | Not required | | | | |
| MISCELLANEOUS | | | | | | |
| 16 | R1 | | Resistor | 220k $\Omega \pm 10$ | | W.20050A/20 |
| 17 | S1 | | Switch | 2-way | | W.20050A/12 |
| 18 | SL1 | | Lamp | 8V 0.2A | | W.20050A/15 |
| 19 | | | Holder for SL1 | | | W.20050A/14 |
| 20 | V1 | | Valve 5Z4G | | | |
| 21 | | | Holder for V1 | | | W.20050A/11 |
| 22 } 23 } 24 } 25 } | | Not required | | | | |
| 26 | | | Bracket (LH) | | | W.20050A/4 |
| 27 | | | Bracket (RH) | | | W.20050A/5 |
| 28 | | | Case for Unit | | | W.20050A/1 |
| 29 | | | Chassis | | | W.20050A/3 |
| 30 | | | Connector (To AC Mains) | | | WIS.3206/C Sh.1 |
| 31 | | | Feet | | | W.20050A/13 |
| 32 | | | Front Panel | | | W.20050A/2 |
| 33 | | | Label | | | W.20050A/38 |
| 34 | | | Plug | 2-pin | | W.20050A/21 |
| 35 | | | Socket | 5-pin | | W.20050A/23 |
| 36 | | | Tag Board (for C1-C3 and R1) | | | W.20050A/16 |
| 37 | | | | | | |

10.5 COMPONENTS AND SPARES LIST REF.: Y/T.2148/1 No. 3
(Origin Sheet WZ.4768/A)

SPECIAL NOTE

When ordering replacements please state the quantity and quote this list reference and item number thus, where X is the item number :—

Qty.....Y/T 2148/1 No. 3/X

SUPPLY UNIT

TYPE 1325/4 and 5

DWG. No. W.25413 Sh. 2

CIRCUIT DIAGRAM No. WZ.4768/B Sh. 1 (Fig. 186)

| Item No. | Unit No. | Circuit Ref. | Description | Value and Tolerance % | Rating | Sched. No./Ref. |
|-------------------|----------|--------------|--------------------|-----------------------|--------|-----------------|
| CAPACITORS | | | | | | |
| 1 | | C1 | Paper Dielectric | 8 μ F \pm 15 | 400V | W.25413A/18 |
| 2 | | C2 | Paper Dielectric | 8 μ F \pm 15 | 400V | W.25413A/18 |
| 3 | | C3 | Paper Dielectric | 8 μ F \pm 15 | 400V | W.25413A/18 |
| 4 | | | | | | |
| 5 | | | | | | |
| FUSES | | | | | | |
| 6 | | F1 | Cartridge | 2 Amp. | | W.25413A/12 |
| 7 | | | Fuse holder for F1 | | | W.25413A/10 |
| 8 | | F2 | Cartridge | 2 Amp. | | W.25413A/12 |
| 9 | | | Fuse holder for F2 | | | W.25413A/10 |

| Item No. | Unit No. | Circuit Ref. | Description | Value and Tolerance % | Rating | Sched. No./Ref. | |
|-------------------------|----------|--------------|-------------------------|-----------------------|--------|------------------|--|
| 10 | | F3 | Cartridge | 500mA | | W.25413A/11 | |
| 11 | | | Fuse holder for F3 | | | W.25413A/10 | |
| 12 | | Not required | | | | | |
| 13 | | | | | | | |
| | | | | | | | |
| CHOKES AND TRANSFORMERS | | | | | | | |
| 14 | | CH1 | Choke, Iron Core | 15-20H | | W.25413/14 | |
| 15 | | CH2 | Choke, Iron Core | 15-20H | | W.25413/14 | |
| 16 | | T1 | Transformer Mains | | | W.25413/13 | |
| 17 | | Not required | | | | | |
| 18 | | | | | | | |
| MISCELLANEOUS | | | | | | | |
| 19 | | R1 | Resistor | 220k $\Omega \pm 10$ | | W.25413A/19 | |
| 20 | | S1 | Switch, DP On/Off | | | W.25413A/15 | |
| 21 | | SL1 | Signal Lamp | 8V 0.2A | | W.25413A/17 | |
| 22 | | | Lamp holder for SL1 | | | W.25413A/16 | |
| 23 | | Not required | | | | | |
| 24 | | MR1 | Rectifier | | | W.25413A/9 | |
| 25 | | Not required | | | | | |
| 26 | | | | | | | |
| 27 | | | | | | | |
| 28 | | | Case for Unit | | | W.25413A/1 | |
| 29 | | | Chassis | | | W.25413A/3 | |
| 30 | | | Clamp | | | W.25413A/4 | |
| 31 | | | Connector (to AC Mains) | | | WIS.3206/C Sh. 1 | |
| 32 | | | Feet | | | W.25413A/8 | |
| 33 | | | Front Panel | | | W.25413A/2 | |
| 34 | | | Plug, Mains | 2-pin | | W.25413A/20 | |
| 35 | | | Socket | 5-pin | | W.25413A/22 | |

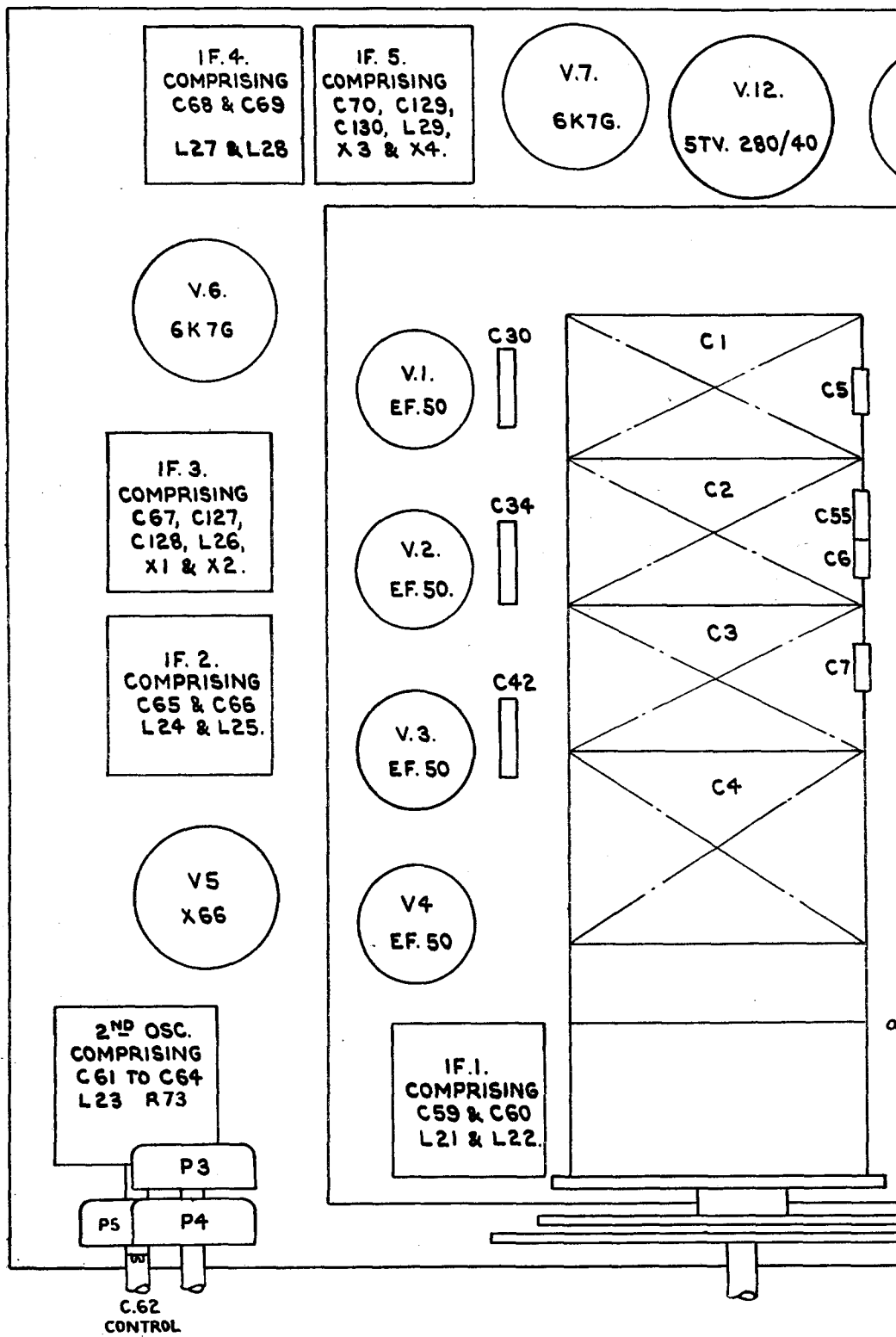

FIG. 7. UP

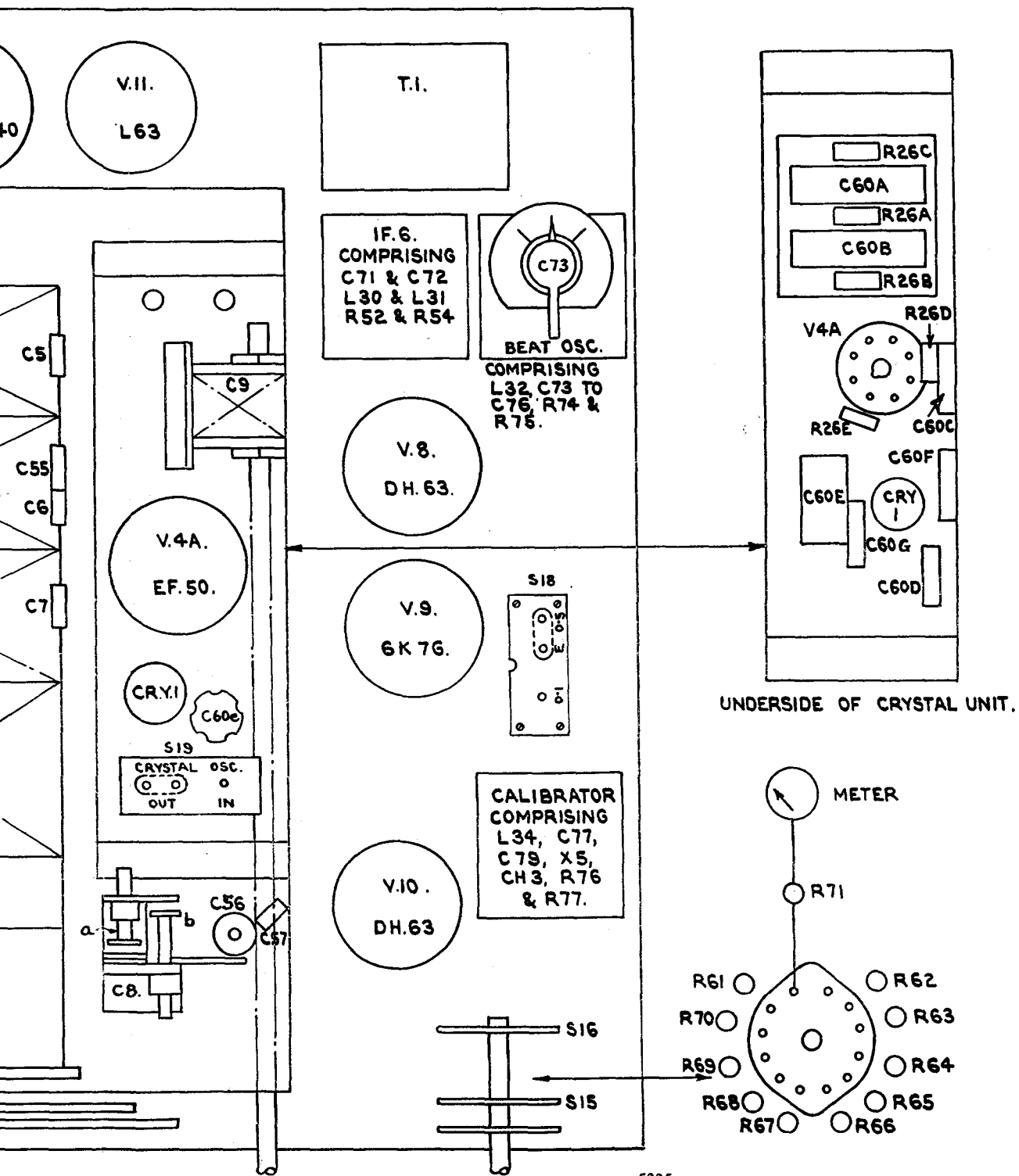

FIG. 7. UPPER DECK PLAN.

Resistance Board—see Fig. 9a.

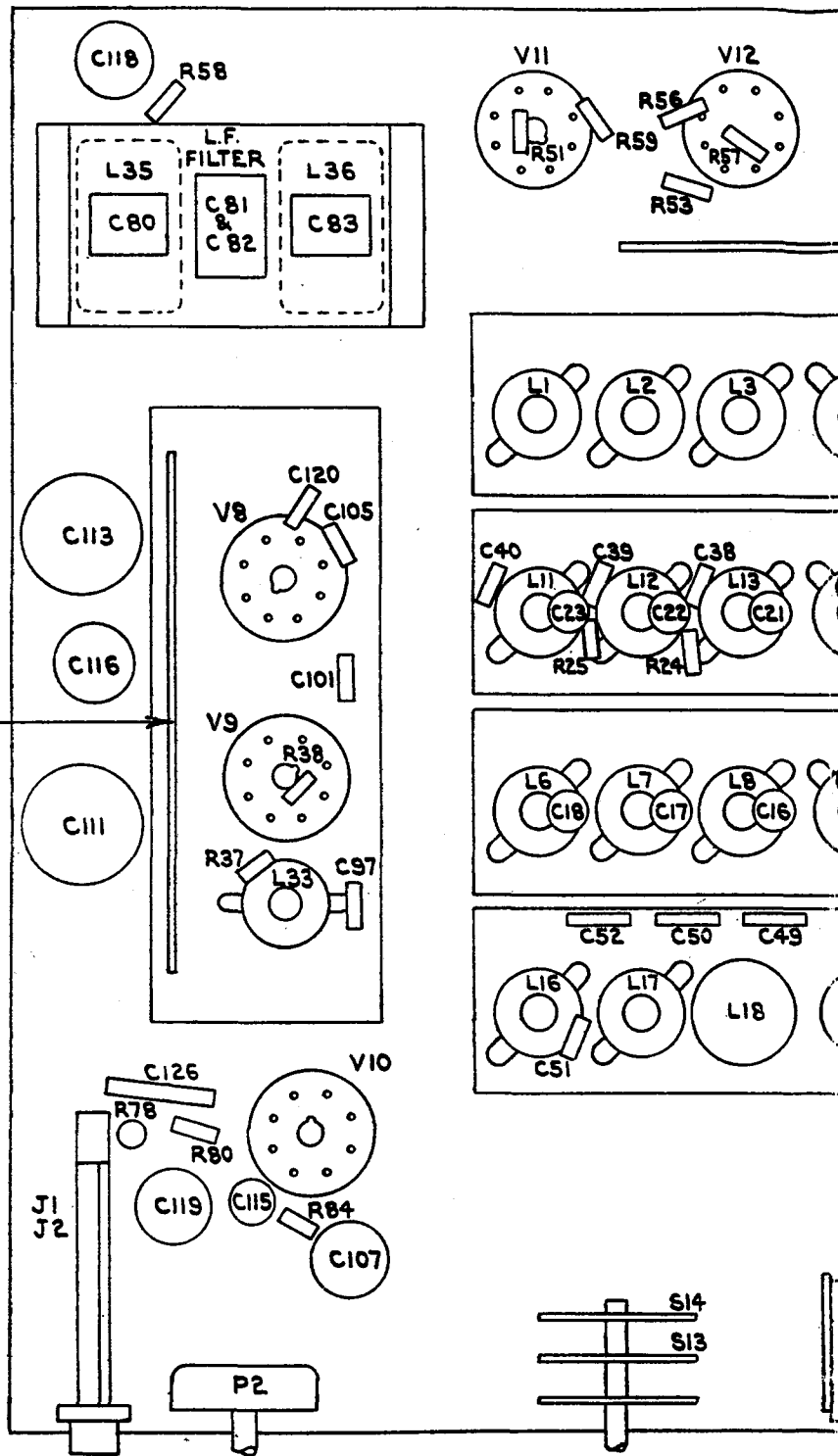
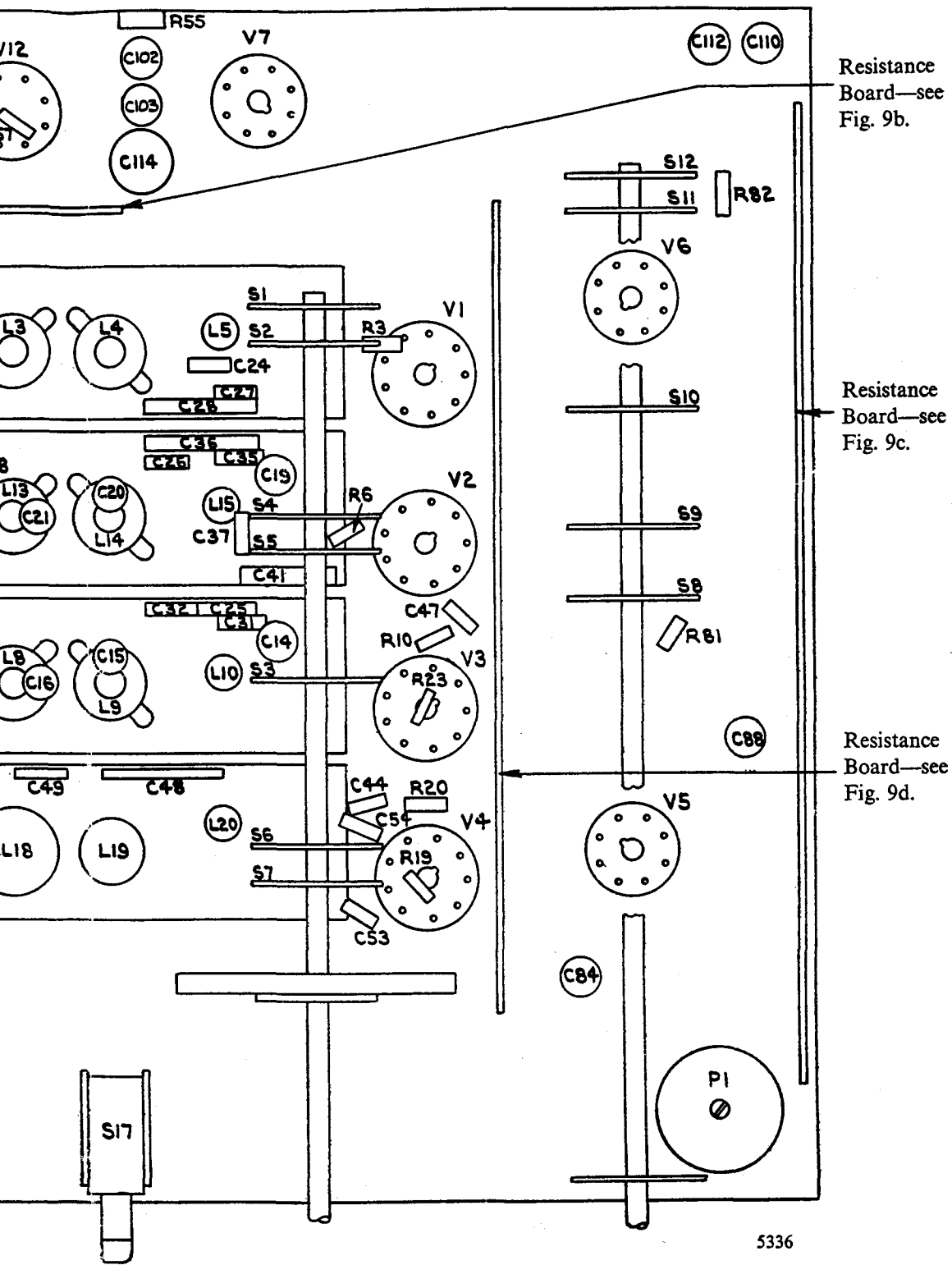
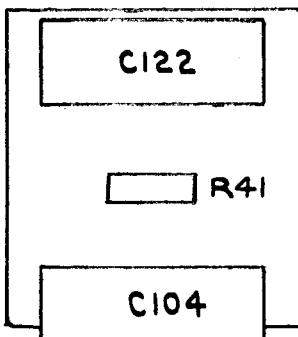
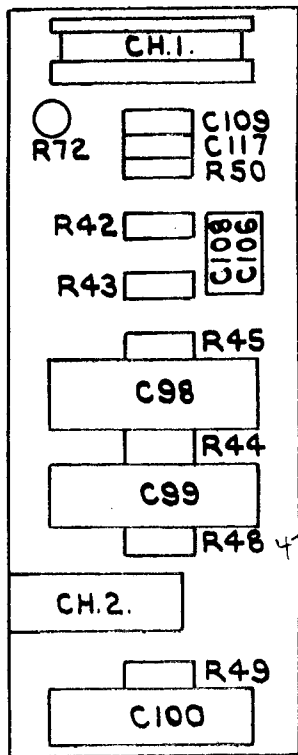

FIG. 8. LOWER



3. LOWER DECK PLAN.

(FIG. 8)
45



(b)

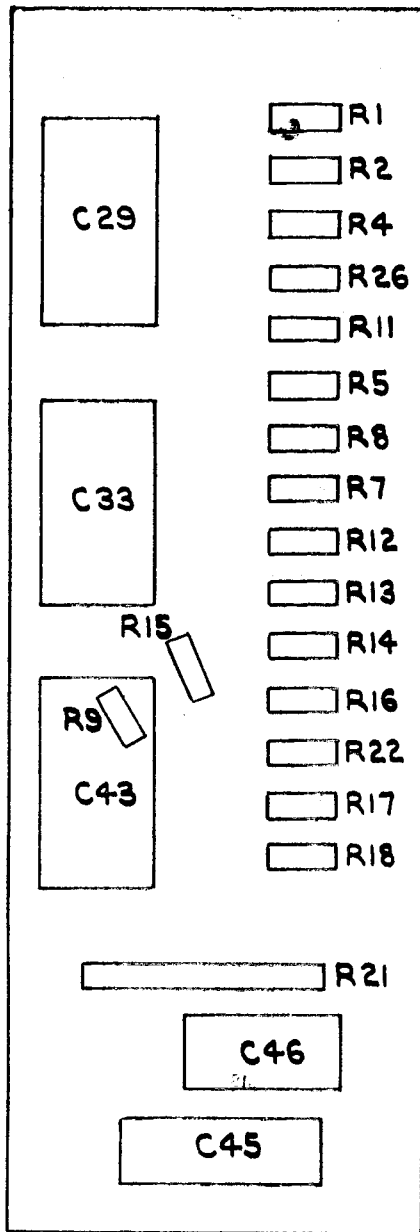

(c)

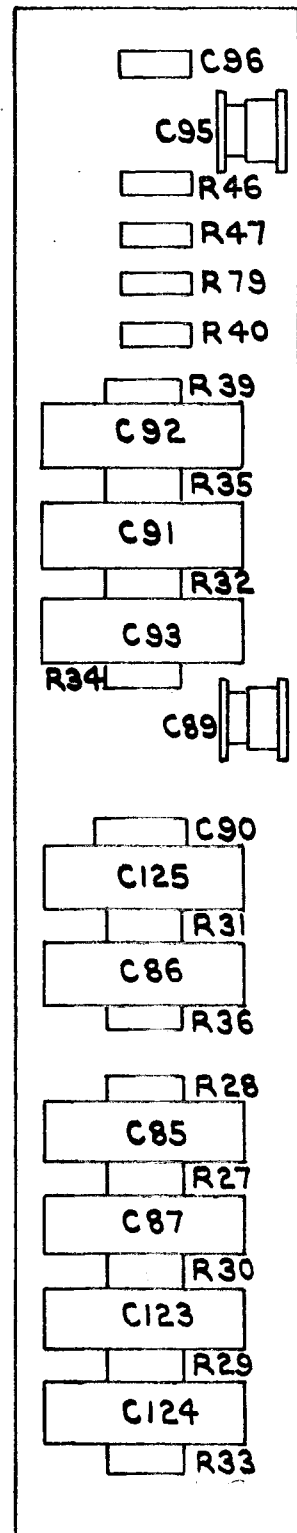

(d)

5337

FIG. 9. RESISTANCE BOARDS.

(FIG. 9)

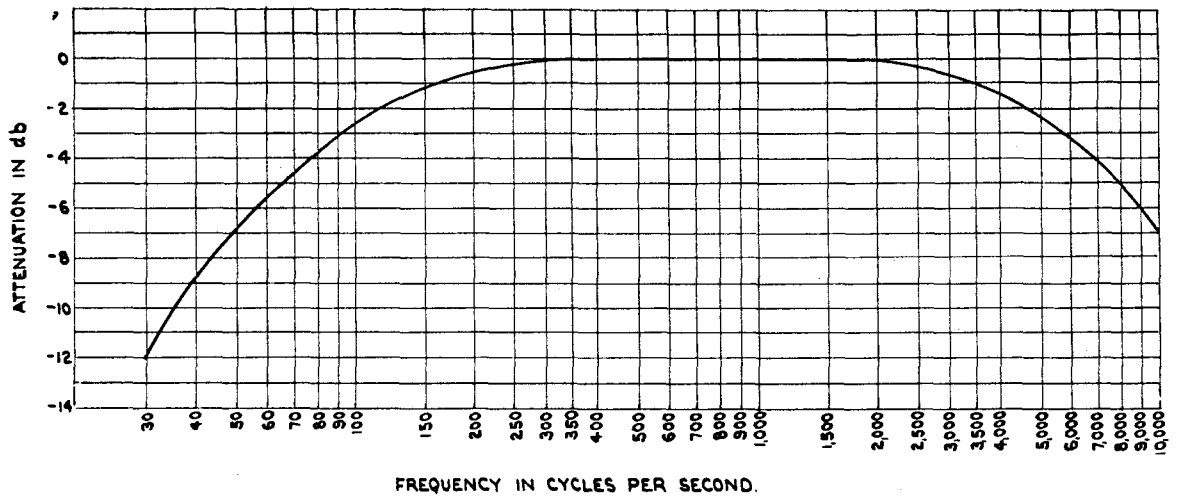

FIG. 10. AUDIO FREQUENCY RESPONSE.

5338

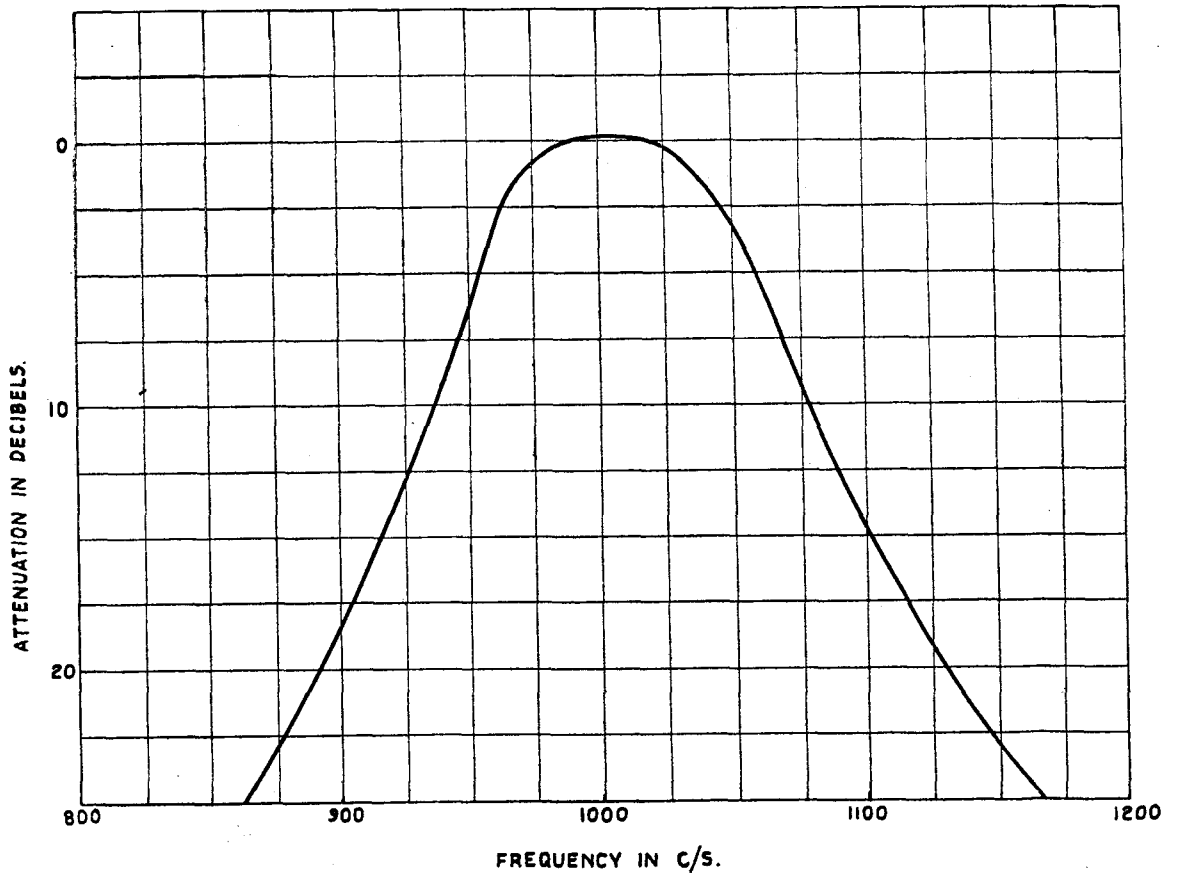
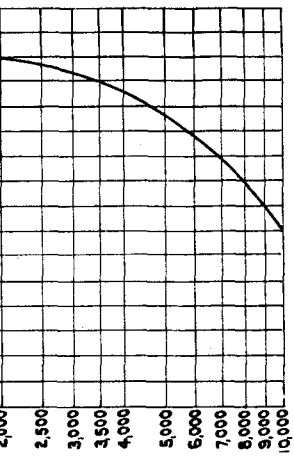
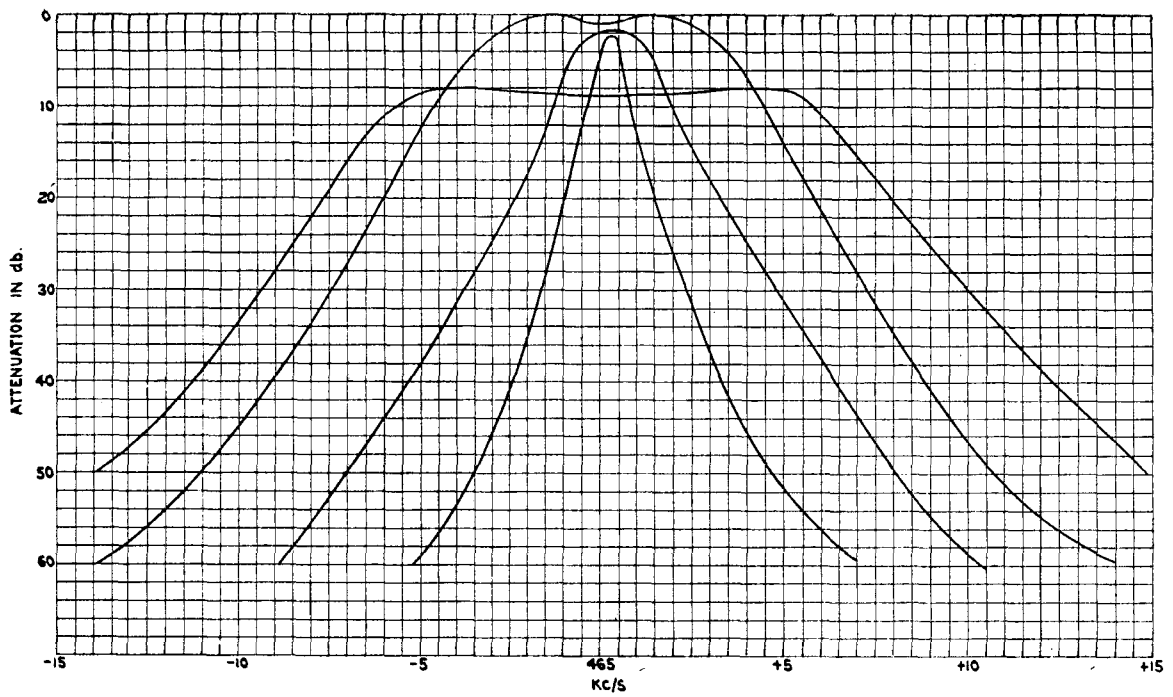

FIG. 11. LF FILTER RESPONSE.

5339



5338



5340

FIG. 12. IF RESPONSE.

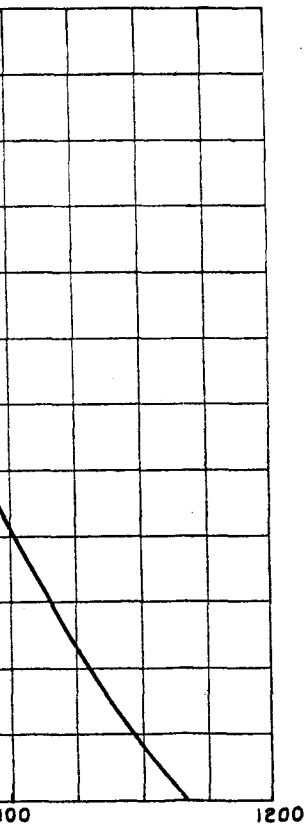

5339

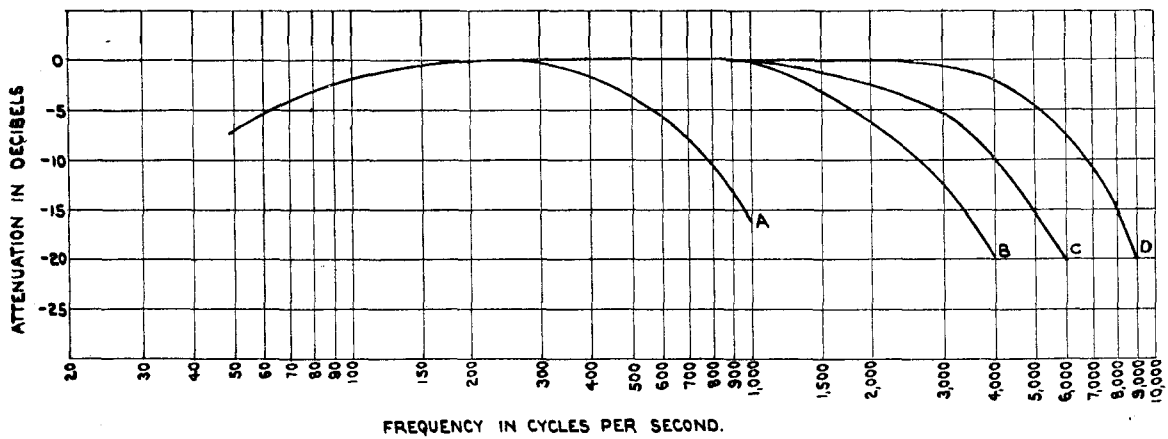

SIGNAL FREQUENCY 5 Mc/S MODULATED 40%
 A. PASSBAND 1,000 C/S.
 B. PASSBAND 3,000 C/S.
 C. PASSBAND 8,000 C/S.
 D. PASSBAND 13,000 C/S

5342

FIG. 14. OVERALL FREQUENCY RESPONSE.

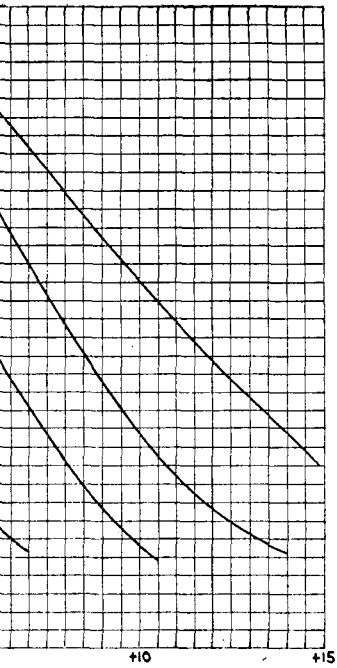

5340

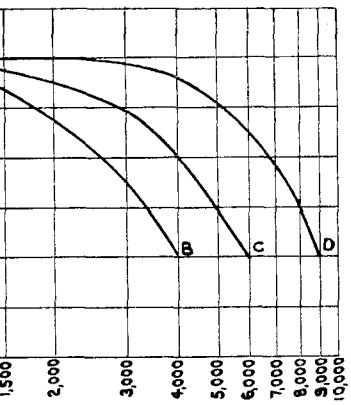

5342

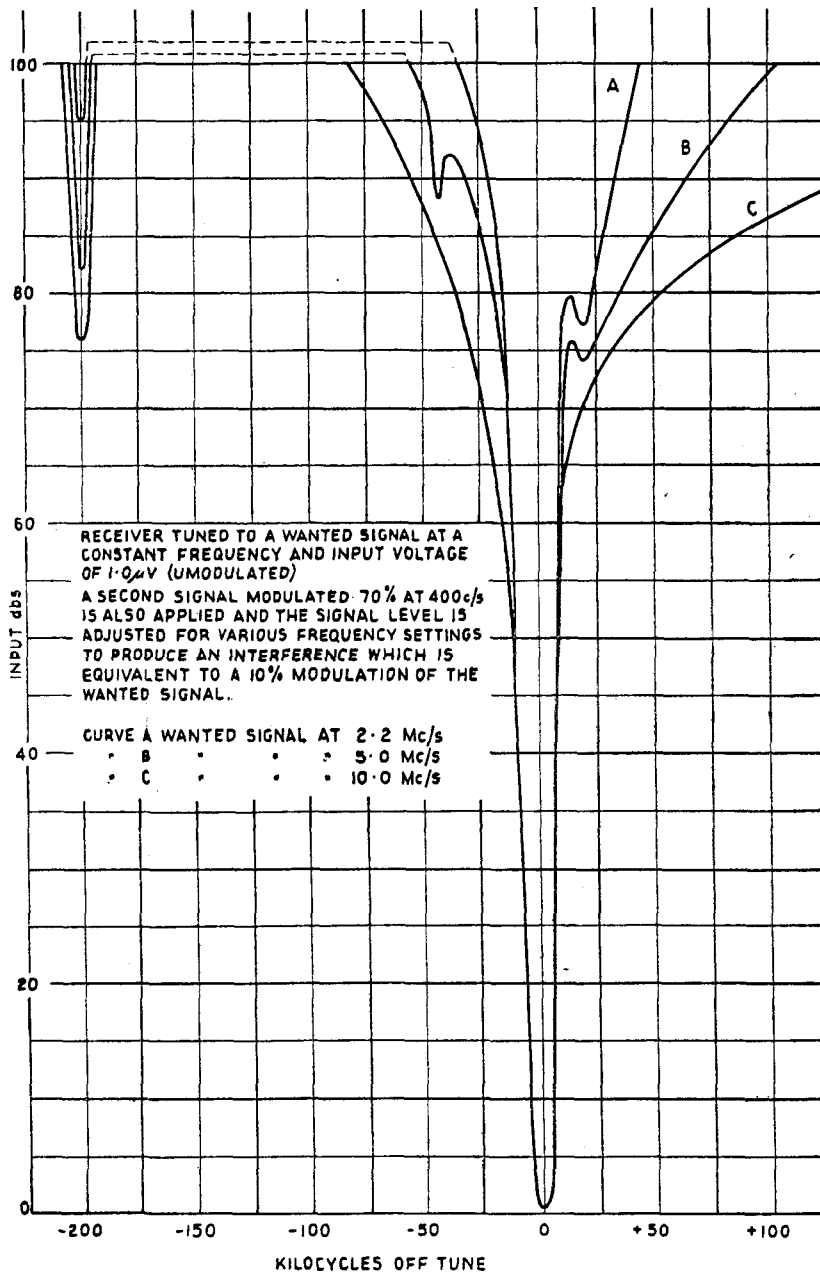

5341

FIG. 13. SELECTIVITY CURVES.

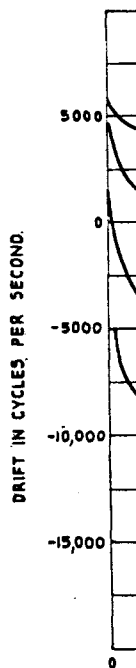
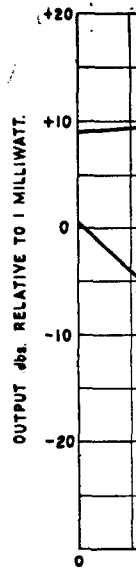

ONSE.

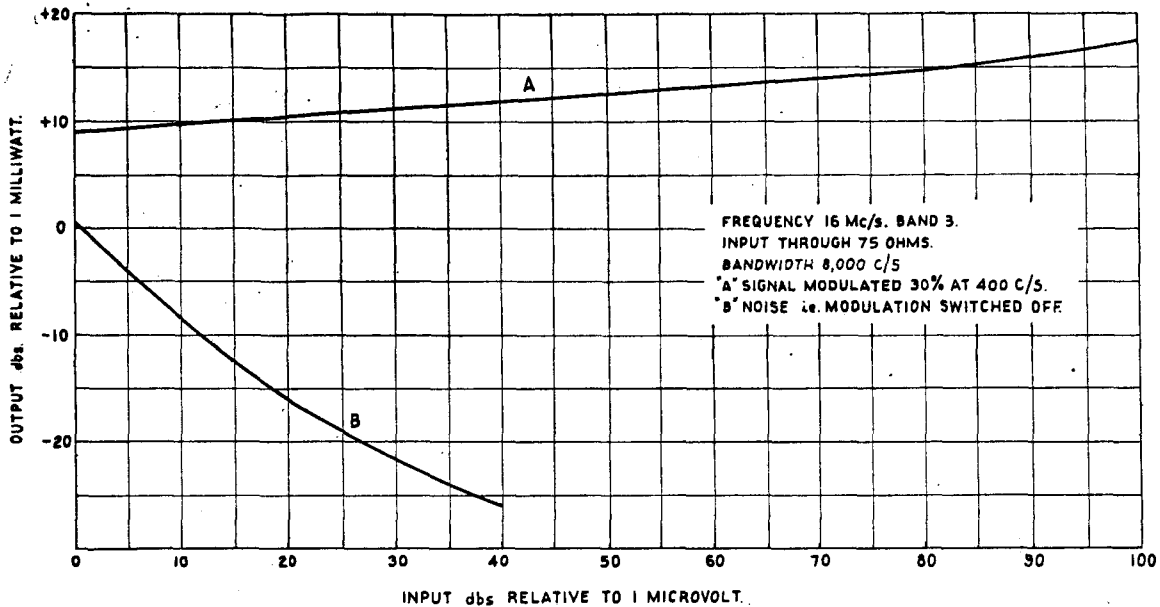

FIG. 15. AGC RESPONSE.

5343

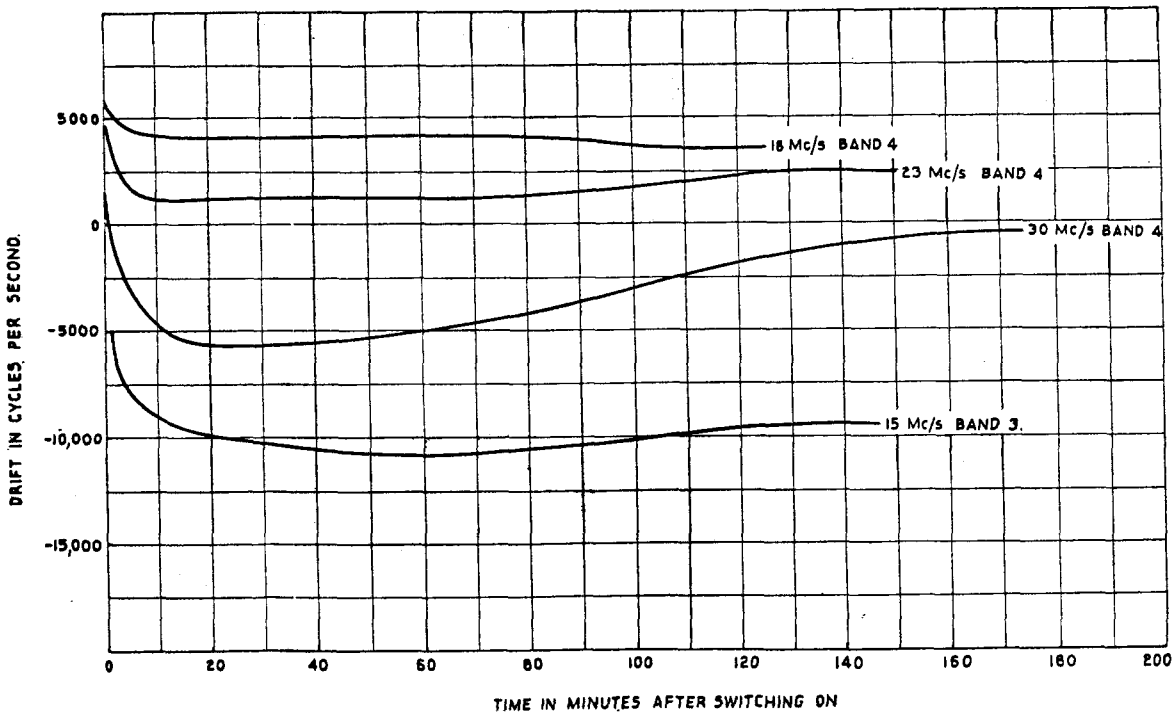

FIG. 16. FREQUENCY DRIFT.

5344

(Figs. 10-16)

COMPONENT LOCATION TABLE

CAPACITORS

RESISTORS

| Ref. Loc. | Ref. Loc. | Ref. Loc. | Ref. Loc. | Ref. Loc. | Ref. Loc. | Ref. Loc. | Ref. Loc. | Ref. Loc. | | | | | | | | | | |
|-----------|-----------|-----------|-----------|-----------|-----------|-----------|-----------|-----------|-----|-----|-----|------|-----|-----|-----|-----|-----|--|
| C1 | 7 B | C28 | 8 B | C55 | 4 C | C75 | 3 O | C102 | 5 N | R1 | 9 B | R23 | 8 H | R40 | 8 N | R62 | 3 D | |
| C2 | 7 C | C29 | 8 C | C56 | 8 H | C76 | 3 P | C103 | 3 N | R2 | 9 B | R24 | 7 D | R41 | 3 N | R63 | 3 G | |
| C3 | 7 F | C30 | 8 C | C57 | 7 H | C77 | 3 Q | C104 | 8 N | R3 | 6 B | R25 | 8 D | R42 | 4 O | R64 | 1 I | |
| C4 | 7 H | C31 | 8 G | C58 | | C78 | | C105 | 5 O | R4 | 8 C | R26 | 9 E | R43 | 5 O | R65 | 1 J | |
| C5 | 7 C | C32 | 8 G | C59 | 3 I | C79 | 3 Q | C106 | 5 O | R5 | 3 C | R26a | 7 J | R44 | 8 O | R66 | 2 K | |
| C6 | 7 C | C33 | 8 F | C60 | 3 I | C80 | 2 P | C107 | 6 O | R6 | 5 E | R26b | 7 J | R45 | 8 O | R67 | 1 J | |
| C7 | 7 F | C34 | 8 E | C60a | 8 J | C81 | 2 Q | C108 | 5 O | R7 | 4 D | R26c | 5 J | R46 | 8 R | R68 | 2 M | |
| C8 | 7 H | C35 | 8 D | C60b | 8 J | C82 | 2 Q | C109 | 8 P | R8 | 4 D | R26d | 8 K | R47 | 8 R | R69 | 2 N | |
| C9 | 7 C | C36 | 8 D | C60c | 8 K | C83 | 2 Q | C110 | 8 Q | R9 | 8 G | R26e | 8 K | R48 | 4 O | R70 | 2 O | |
| C10 | | C37 | 4 D | C60d | 8 K | C84 | 4 I | C111 | 8 N | R10 | 5 G | R27 | 1 K | R49 | 3 O | R71 | 1 G | |
| C11 | | C38 | 6 D | C60e | 8 K | C85 | 6 K | C112 | 8 Q | R11 | 8 E | R28 | 8 K | R50 | 5 P | R72 | 8 O | |
| C12 | | C39 | 7 D | C60f | 8 K | C86 | 8 K | C113 | 4 O | R12 | 2 F | R29 | 2 J | R51 | 8 R | R73 | 3 K | |
| C13 | | C40 | 8 D | C60g | 7 K | C87 | 8 K | C114 | 2 P | R13 | 4 G | R30 | 3 K | R52 | 3 N | R74 | 3 P | |
| C14 | 5 G | C41 | 8 E | C61 | 3 K | C88 | 8 L | C115 | 8 P | R14 | 4 G | R31 | 8 L | R53 | 8 R | R75 | 3 O | |
| C15 | 5 G | C42 | 7 H | C62 | 2 K | C89 | 8 K | C116 | 8 Q | R15 | 8 H | R32 | 1 L | R54 | 3 O | R76 | 4 Q | |
| C16 | 6 G | C43 | 6 H | C63 | 2 K | C90 | 8 L | C117 | 8 O | R16 | 8 H | R33 | 2 H | R55 | 7 R | R77 | 4 Q | |
| C17 | 7 G | C44 | 5 H | C64 | 3 K | C91 | 8 L | C118 | 5 S | R17 | 1 H | R34 | 8 M | R56 | 1 S | R78 | 8 S | |
| C18 | 8 G | C45 | 4 I | C65 | 5 L | C92 | 8 M | C119 | 8 Q | R18 | 2 I | R35 | 1 M | R57 | 6 S | R79 | 7 Q | |
| C19 | 5 D | C46 | 4 J | C66 | 6 L | C93 | 8 M | C120 | 4 O | R19 | 4 J | R36 | 4 J | R58 | 5 R | R80 | 4 Q | |
| C20 | 6 D | C47 | 4 F | C67 | 3 L | C94 | | C121 | | R20 | 6 J | R37 | 3 P | R59 | 2 S | R81 | 7 L | |
| C21 | 6 D | C48 | 6 I | C68 | 5 M | C95 | 8 M | C122 | 8 R | R21 | 4 J | R38 | 4 P | R60 | | R82 | 7 M | |
| C22 | 7 D | C49 | 6 I | C69 | 6 M | C96 | 8 M | C123 | 8 N | R22 | 2 J | R39 | 1 N | R61 | 2 P | R83 | | |
| C23 | 8 D | C50 | 7 I | C70 | 3 M | C97 | 4 P | C124 | 8 R | | | | | | | R84 | 6 P | |
| C24 | 5 B | C51 | 8 I | C71 | 3 N | C98 | 8 P | C125 | 8 R | | | | | | | | | |
| C25 | 5 G | C52 | 8 I | C72 | 3 O | C99 | 8 P | C126 | 5 Q | | | | | | | | | |
| C26 | 5 D | C53 | 6 J | C73 | 2 P | C100 | 8 P | C127 | 3 L | | | | | | | | | |
| C27 | 8 B | C54 | 5 I | C74 | 3 P | C101 | 4 P | C128 | 3 L | | | | | | | | | |
| | | | | | | | | C129 | 3 M | | | | | | | | | |
| | | | | | | | | C130 | 3 M | | | | | | | | | |

COMPONENT LOCATION TABLE

| TRANS- FORMERS | INDUCTANCES | | POTENTIO- METERS | | SWITCHES | | VALVES | | IF UNITS | | CHOKES | | METER | | | | |
|-------------------|-------------|-----------|---------------------|-----------|-----------|-----------|-----------|-----------|-----------|-----------|-----------|-----------|-----------|-----------|------|-------|-----|
| Ref. Loc. | Ref. Loc. | Ref. Loc. | Ref. Loc. | Ref. Loc. | Ref. Loc. | Ref. Loc. | Ref. Loc. | Ref. Loc. | Ref. Loc. | Ref. Loc. | Ref. Loc. | Ref. Loc. | Ref. Loc. | Ref. Loc. | | | |
| T1 | 4 R | L1 | 7 A | L19 | 5 I | P1 | 1 M | S1 | 5 A | V1 | 5 C | I.F.1 | 3 I | CH.1 | 7 O | M1 | 1 G |
| | | L2 | 7 A | L20 | 5 I | P2 | 8 O | S2 | 6 B | V2 | 5 E | I.F.2 | 6 L | CH.2 | 7 P | | |
| | | L3 | 6 A | L21 | 3 I | P3 | 8 R | S3 | 5 F | V3 | 5 H | I.F.3 | 3 L | CH.3 | 3 Q | | |
| | | L4 | 5 A | L22 | 3 I | P4 | 8 N | S4 | 6 C | V4 | 5 J | I.F.4 | 6 M | | | | |
| | | L5 | 5 A | L23 | 2 K | P5 | 9 R | S5 | 5 E | V5 | 5 K | I.F.5 | 3 M | | | | |
| | | L6 | 7 G | L24 | 5 L | | | S6 | 6 H | V6 | 5 M | I.F.6 | 2 N | | | | |
| | | L7 | 7 G | L25 | 5 L | | | S7 | 6 J | V7 | 5 N | 2nd | | | | | |
| | | L8 | 6 G | L26 | 3 L | | | S8 | 7 L | V8 | 5 O | Osc. | 2 K | | | | |
| | | L9 | 5 G | L27 | 5 M | | | S9 | 4 G | V9 | 5 P | 3rd | | | | | |
| | | L10 | 5 G | L28 | 5 M | | | S10 | 1 Q | V10 | 5 Q | Osc. | 2 O | | | | |
| | | L11 | 7 D | L29 | 3 M | | | S11 | 7 M | V11 | 5 R | | | | | | |
| | | L12 | 7 D | L30 | 3 N | | | S12 | 4 M | V12 | 5 R | CRYSTALS | | LAMPS | | JACKS | |
| | | L13 | 6 D | L31 | 3 N | | | S13 | 2 D | | | | | | | | |
| | | L14 | 5 D | L32 | 2 P | | | S14 | 7 Q | | | | | | | | |
| | | L15 | 5 D | L33 | 4 P | | | S15 | 2 F | | | | | | | | |
| | | L16 | 7 I | L34 | 3 Q | | | S16 | 2 G | | | X1 | } 3 L | IL.1 | 2 B | J1 | 6 S |
| | | L17 | 7 I | L35 | 2 Q | | | S17 | 2 S | | | X2 | | | IL.2 | 2 B | J2 |
| | | L18 | 6 I | L36 | 2 Q | | | S18 | 8 Q | | | X3 | } 3 M | | | | |
| | | | | | | | | S19 | 7 K | | | X4 | | | | | |
| | | | | | | | | | | | | X5 | 4 Q | | | | |

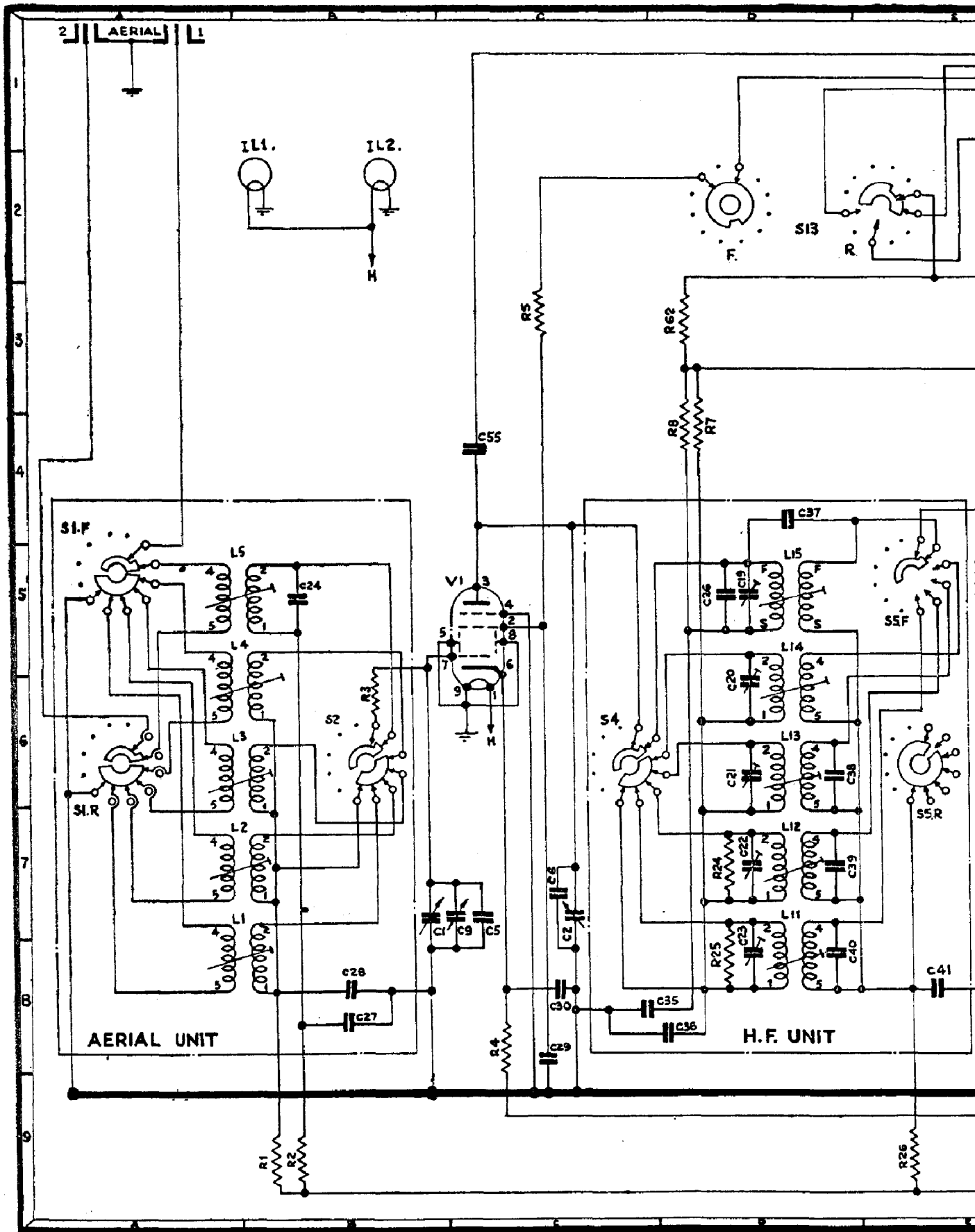

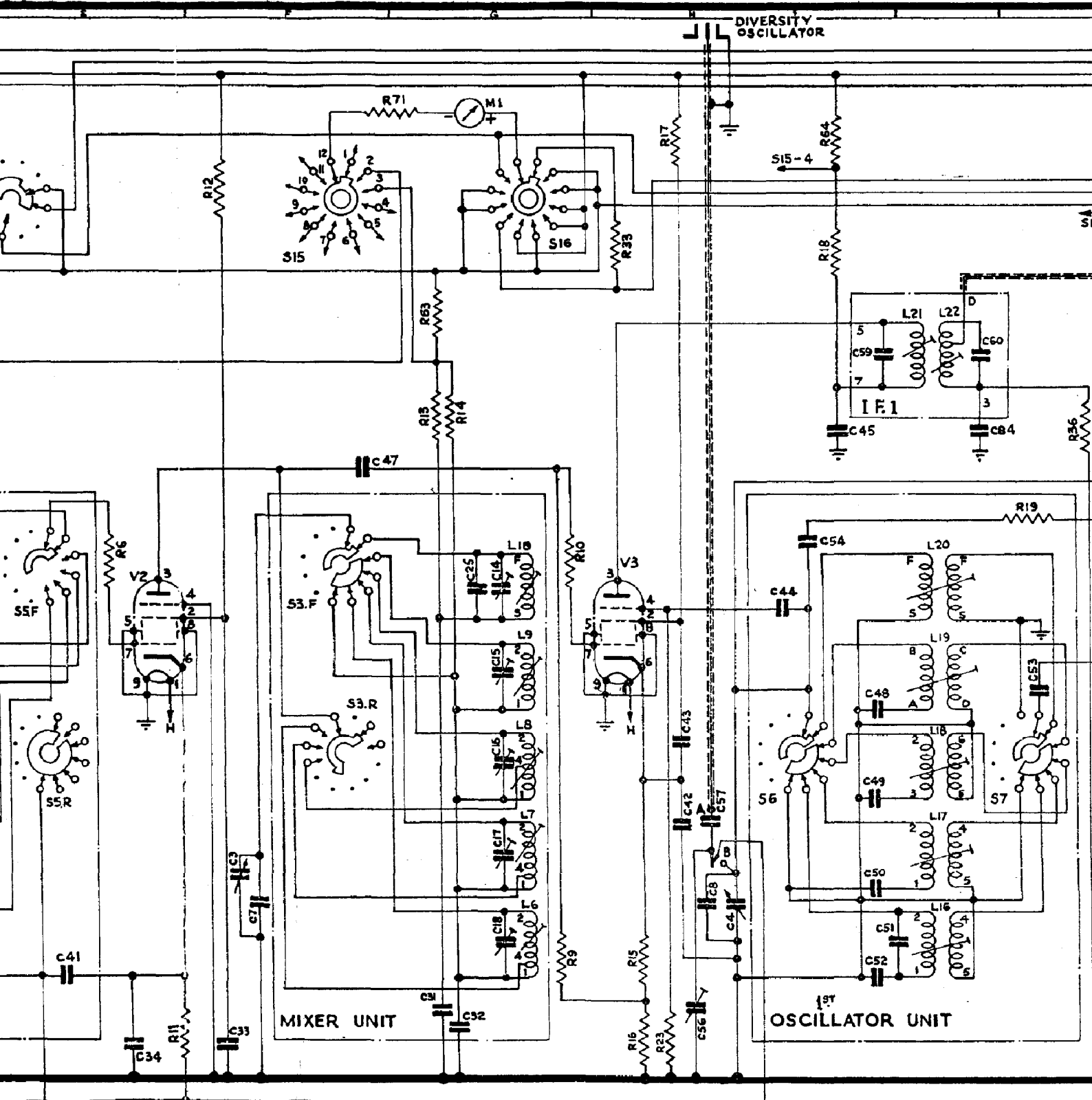

WHEN RECEIVER FORMS PART OF A DIVERSITY EQUIPMENT THIS LEAD IS CONNECTED TO A POINT 'B', CB IS DISCONNECTED & V4 REMOVED FROM ITS VALVEHOLDER. WHEN RECEIVER IS USED SINGLY THIS LEAD IS CONNECTED TO POINT 'A' BY TEST DEPARTMENT.

* WHEN RECEIVER IS USED AS FIRST OSCILLATOR, V4 & PLUGGED IN AS V4A

FIG. 17. CIRCUIT DIAGRAM

RECEIVER IS USED WITH CRYSTAL CONTROLLED OSCILLATOR, V4 IS REMOVED FROM ITS VALVEHOLDER AND USED IN AS V4A. U-LINK TO BE IN 'IN' POSITION.

CIRCUIT DIAGRAM OF RECEIVER

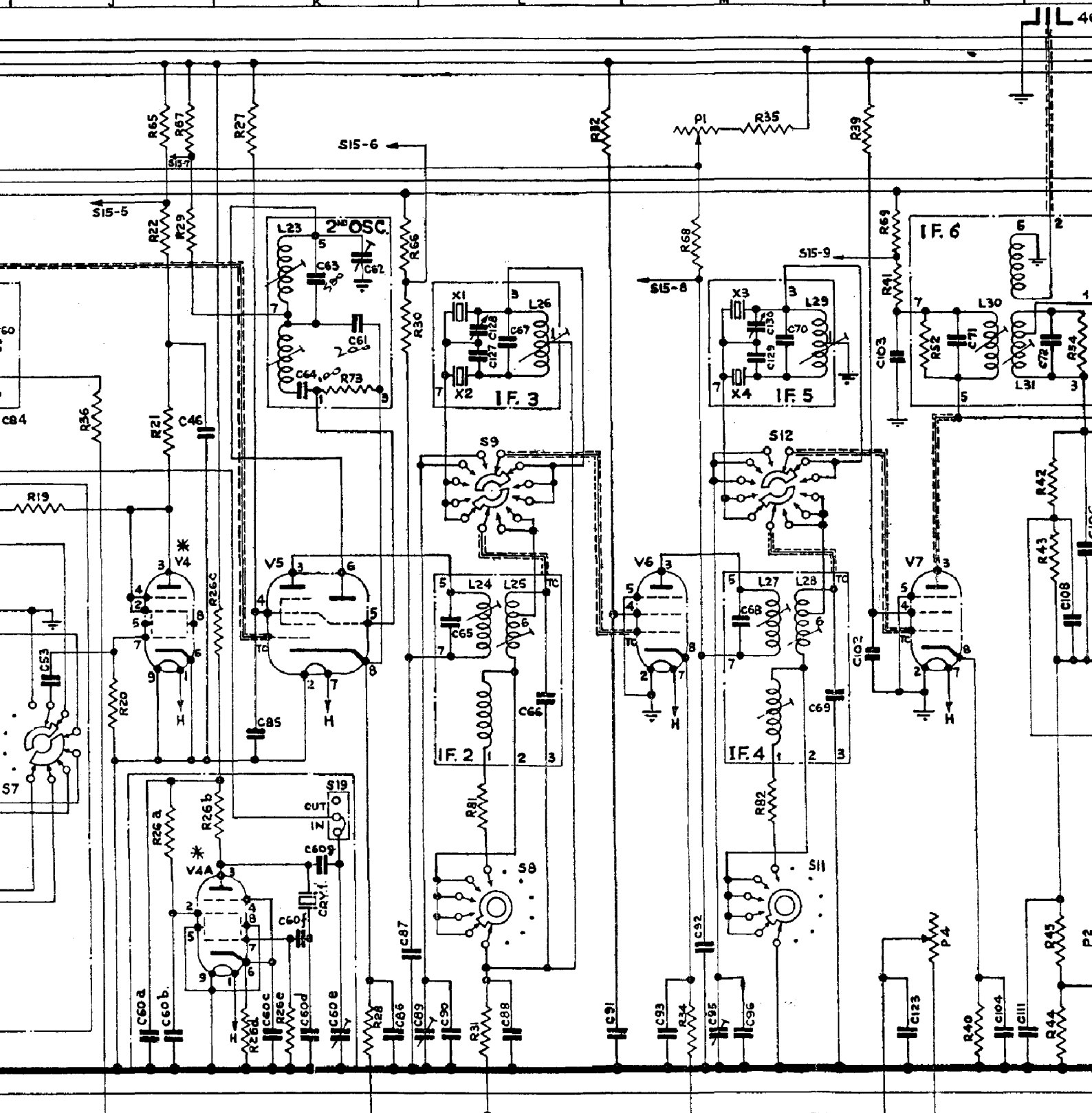

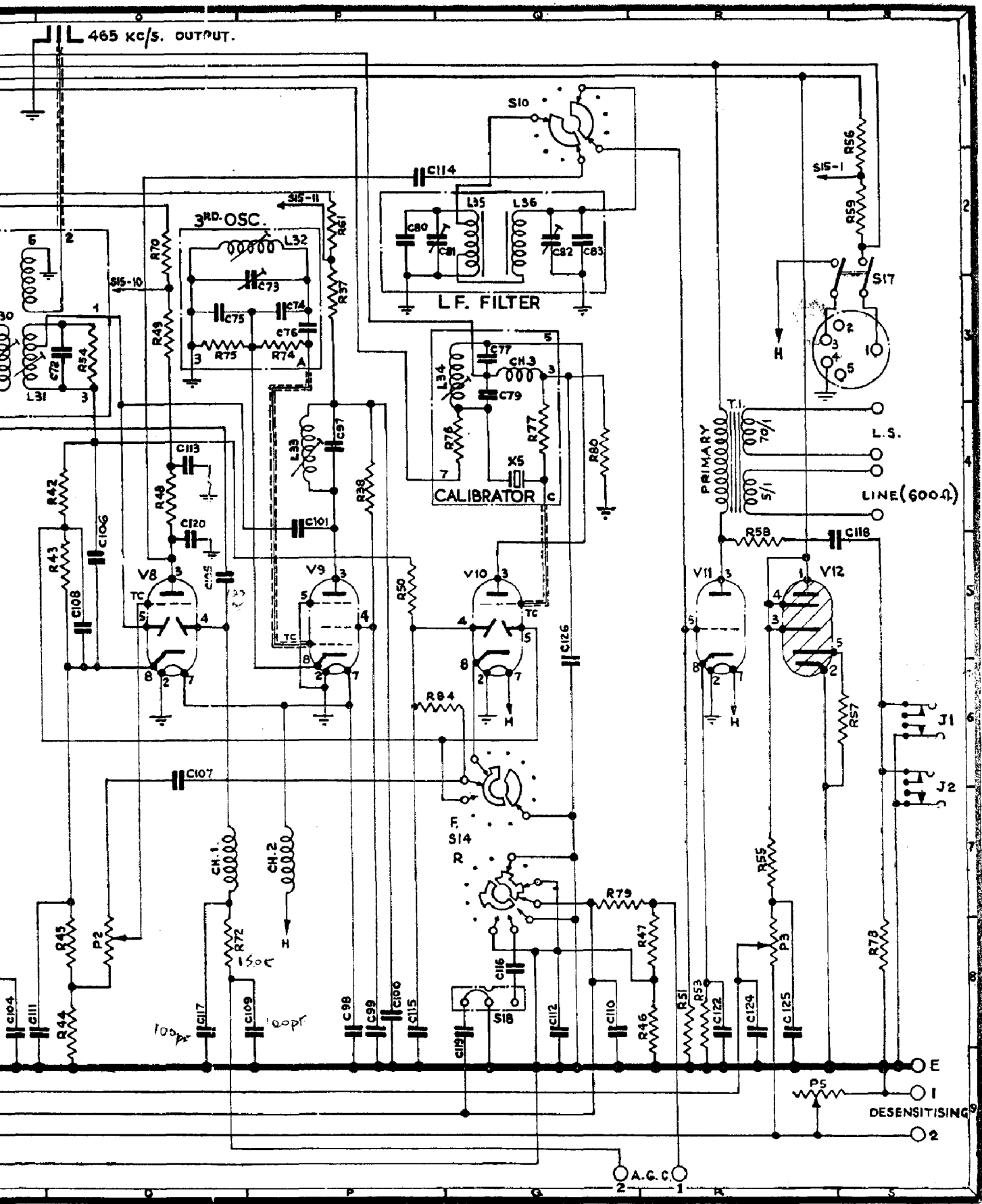

5345
 (FIG. 17)
 48

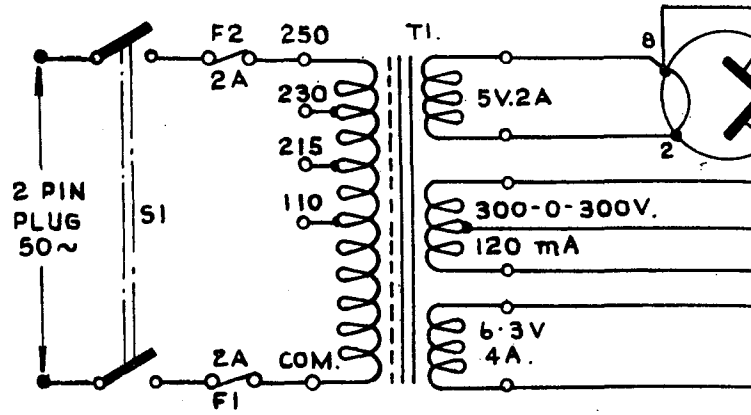

FIG. 18a. CIRCUIT DIAGRAM

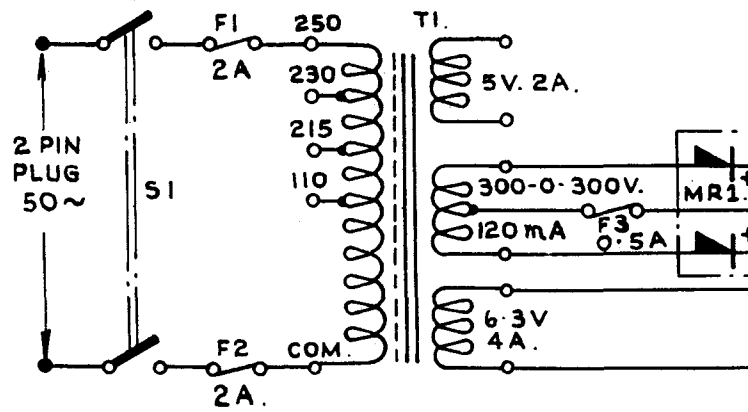
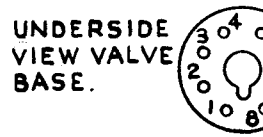
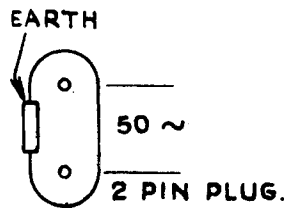
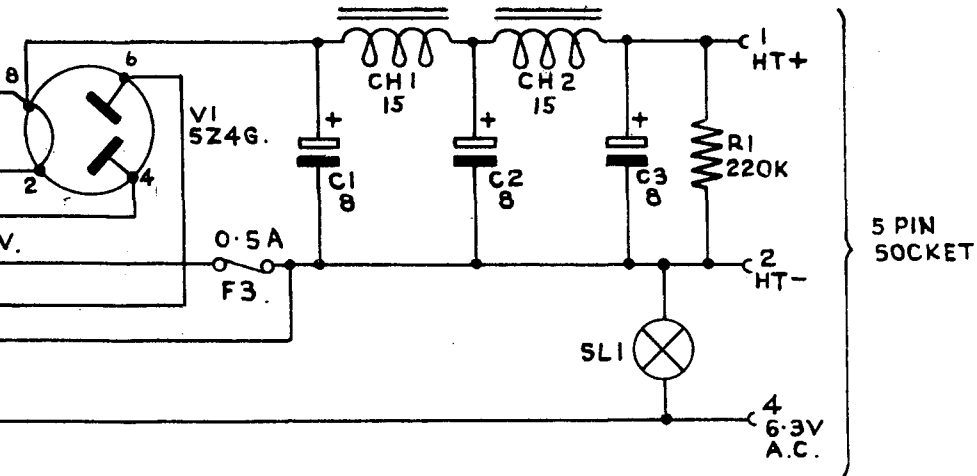
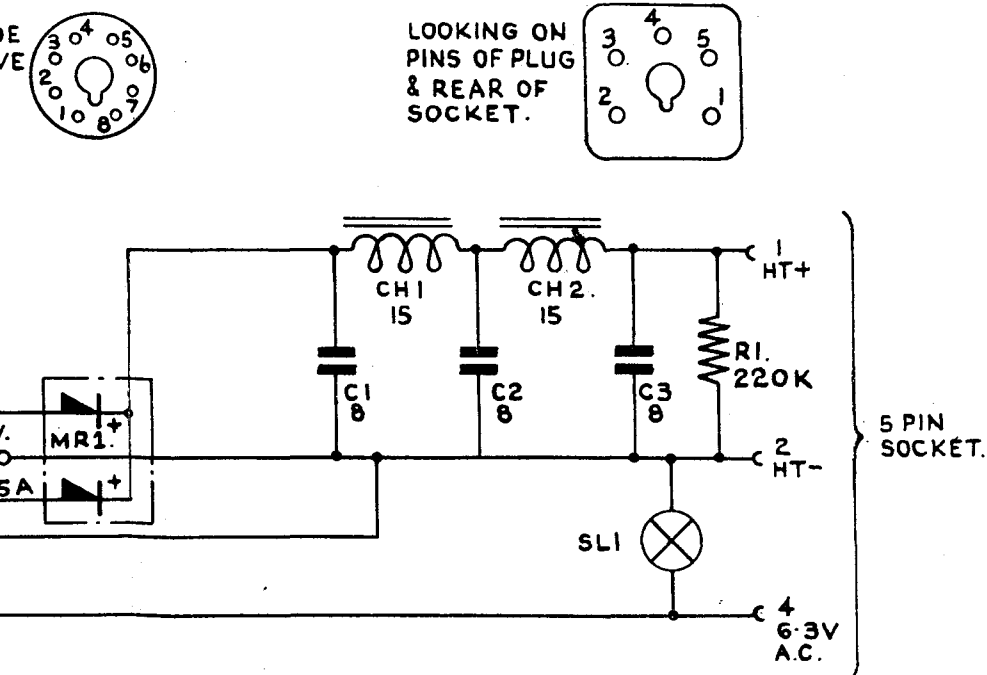

FIG. 18b. CIRCUIT DIAGRAM



5346

DIAGRAM OF SUPPLY UNIT TYPE 1325/1, 2 AND 3.



5347

DIAGRAM OF SUPPLY UNIT TYPE 1325/4 AND 5.

(Fig. 18)

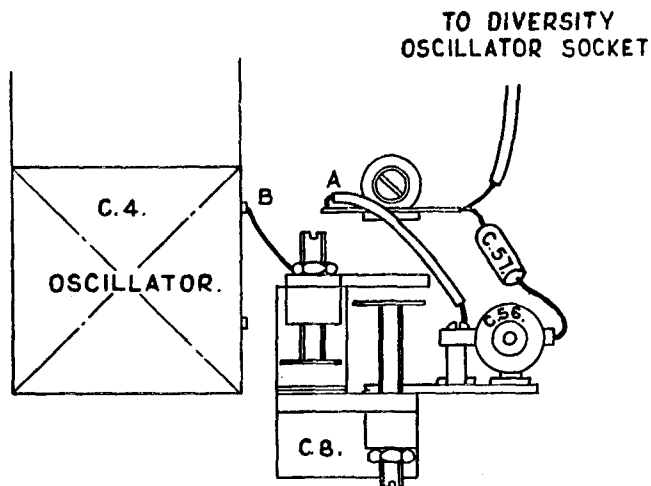

NORMAL RECEIVER CONNECTIONS
 LEAD FROM CONDENSER C.56 CONNECTED TO POINT A
 LEAD FROM COMPENSATOR C.8 CONNECTED TO POINT B

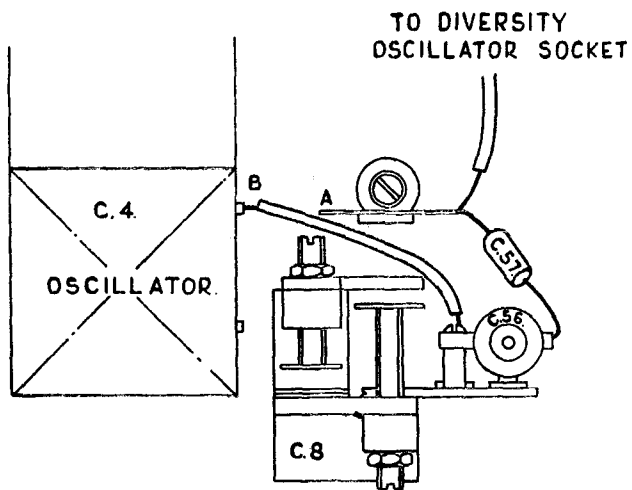

DIVERSITY RECEIVER CONNECTIONS
 LEAD FROM COMPENSATOR C.8 TAKEN OFF POINT B
 LEAD FROM CONDENSER C.56 CONNECTED TO POINT A
 CONDENSER C.56 TO BE ADJUSTED AT 30 Mc/s TO GIVE
 MAXIMUM RECEIVER GAIN

FIG. 21. 1st OSCILLATOR DIVERSITY CONNECTIONS.

5350

(Figs. 19-21)



MARCONI'S WIRELESS TELEGRAPH COMPANY LIMITED

Head Office: Marconi House, Chelmsford · Telephone: Chelmsford 3221 · Telegraphic Address: Expanse, Chelmsford

29054/250

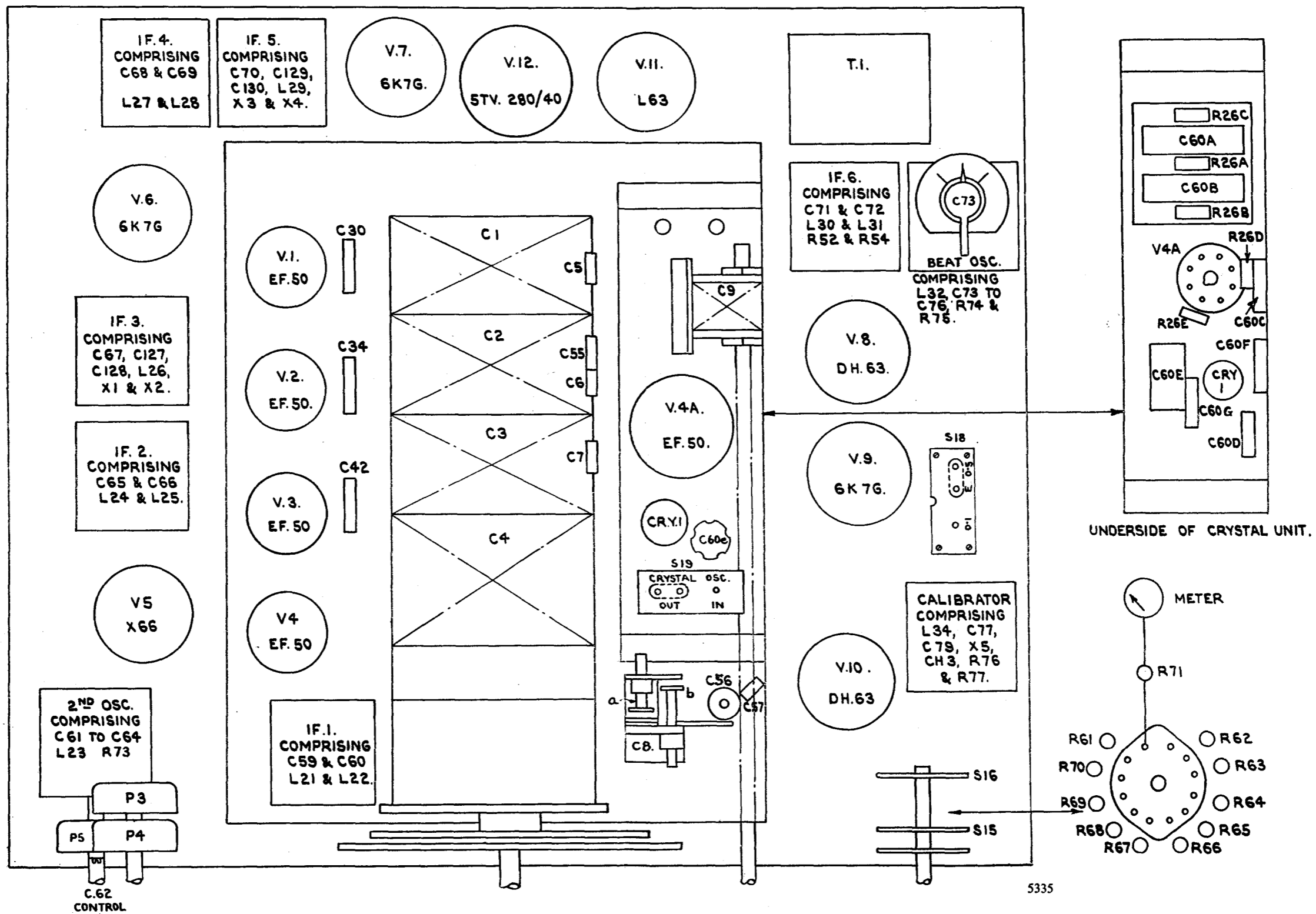

FIG. 7. UPPER DECK PLAN.

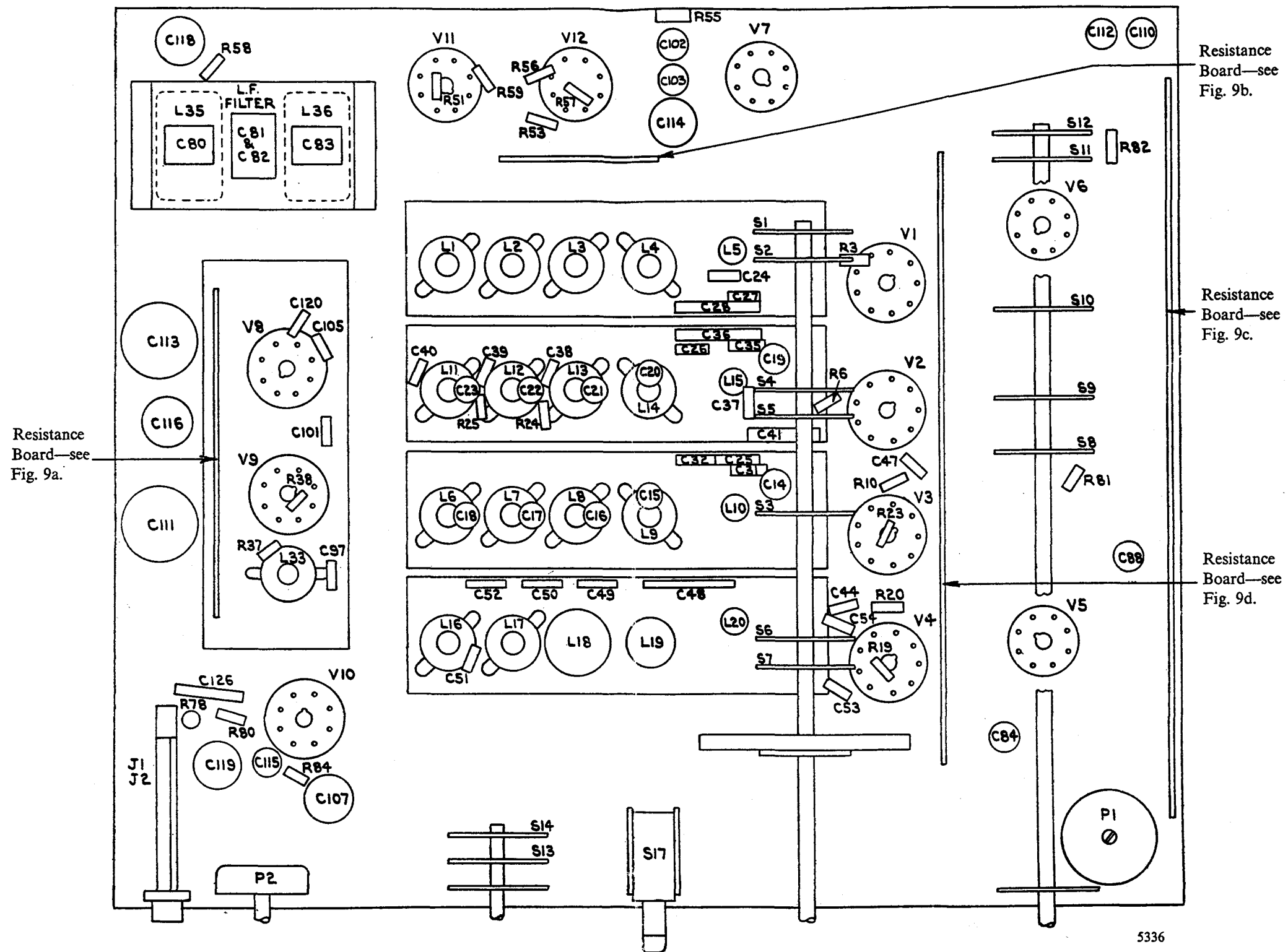

FIG. 8. LOWER DECK PLAN.

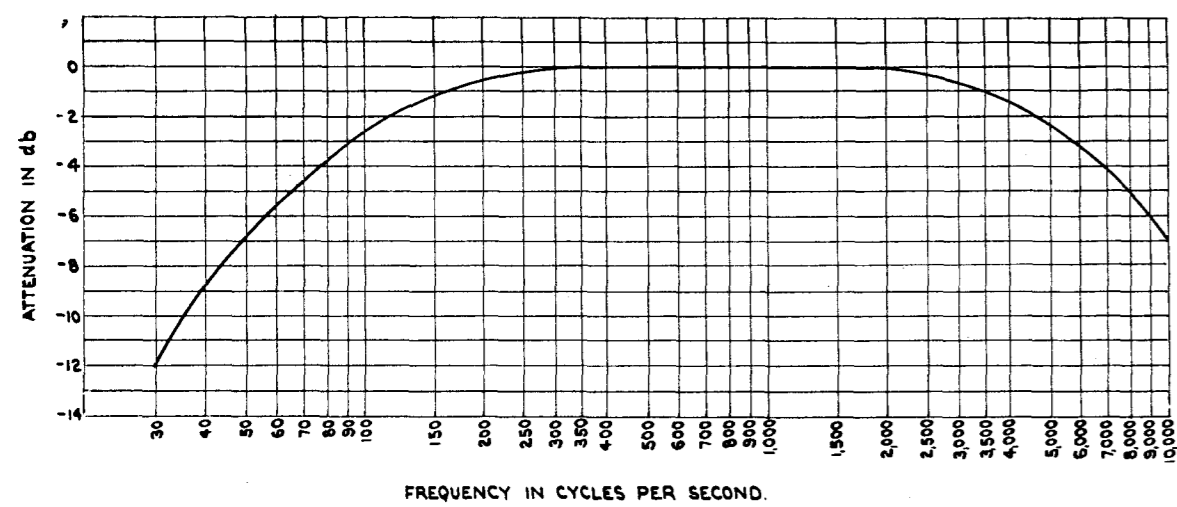

FIG. 10. AUDIO FREQUENCY RESPONSE.

5338

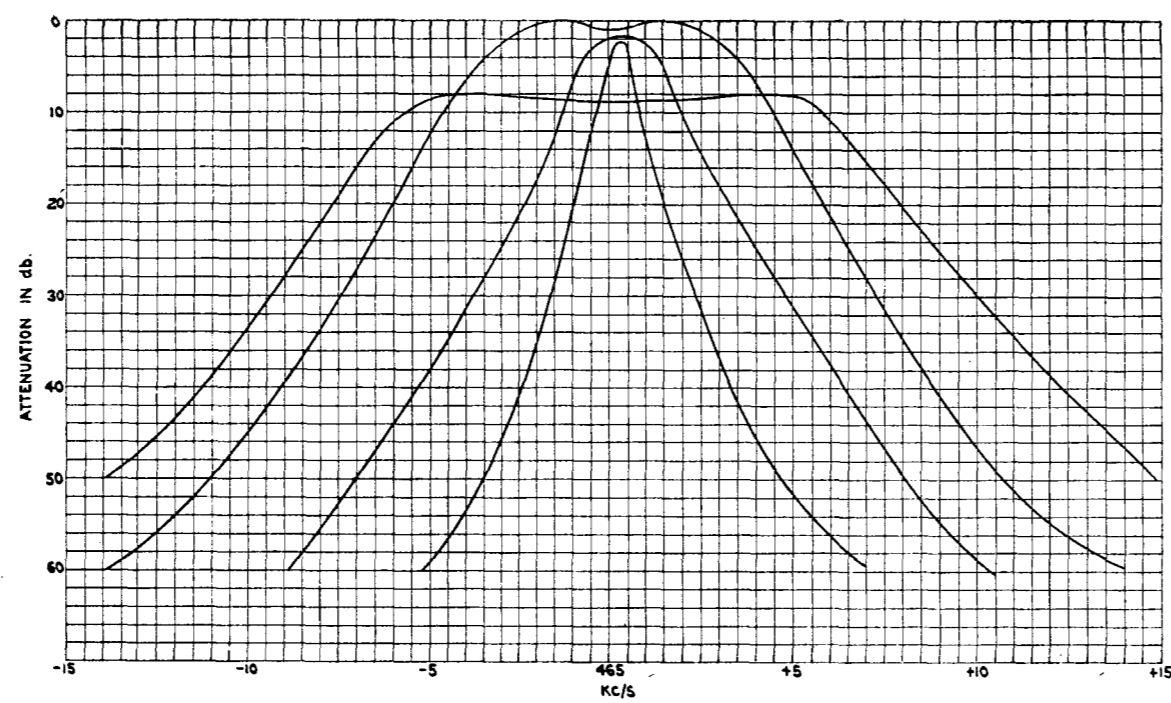

FIG. 12. IF RESPONSE.

5340

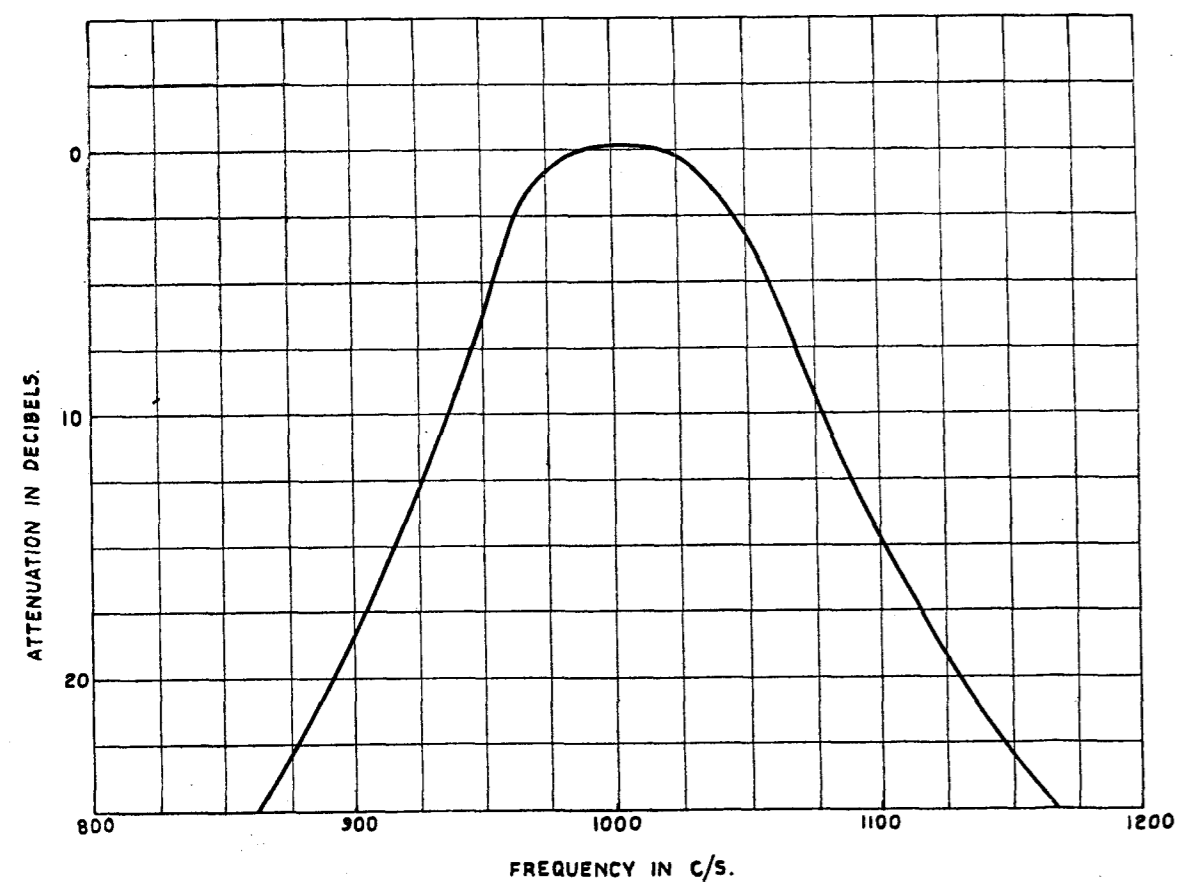

FIG. 11. LF FILTER RESPONSE.

5339

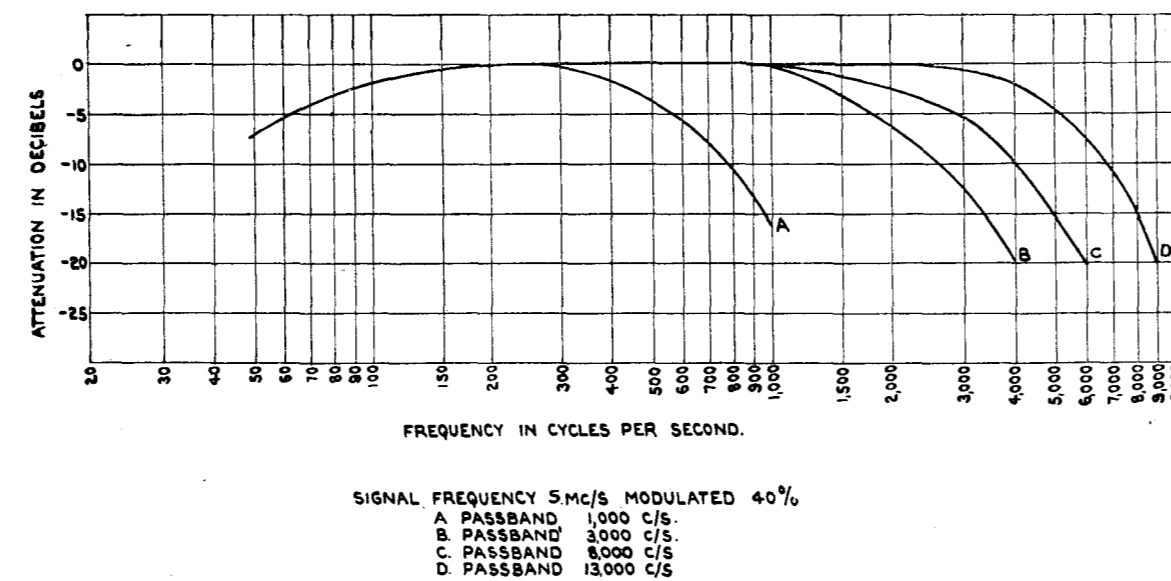

FIG. 14. OVERALL FREQUENCY RESPONSE.

5342

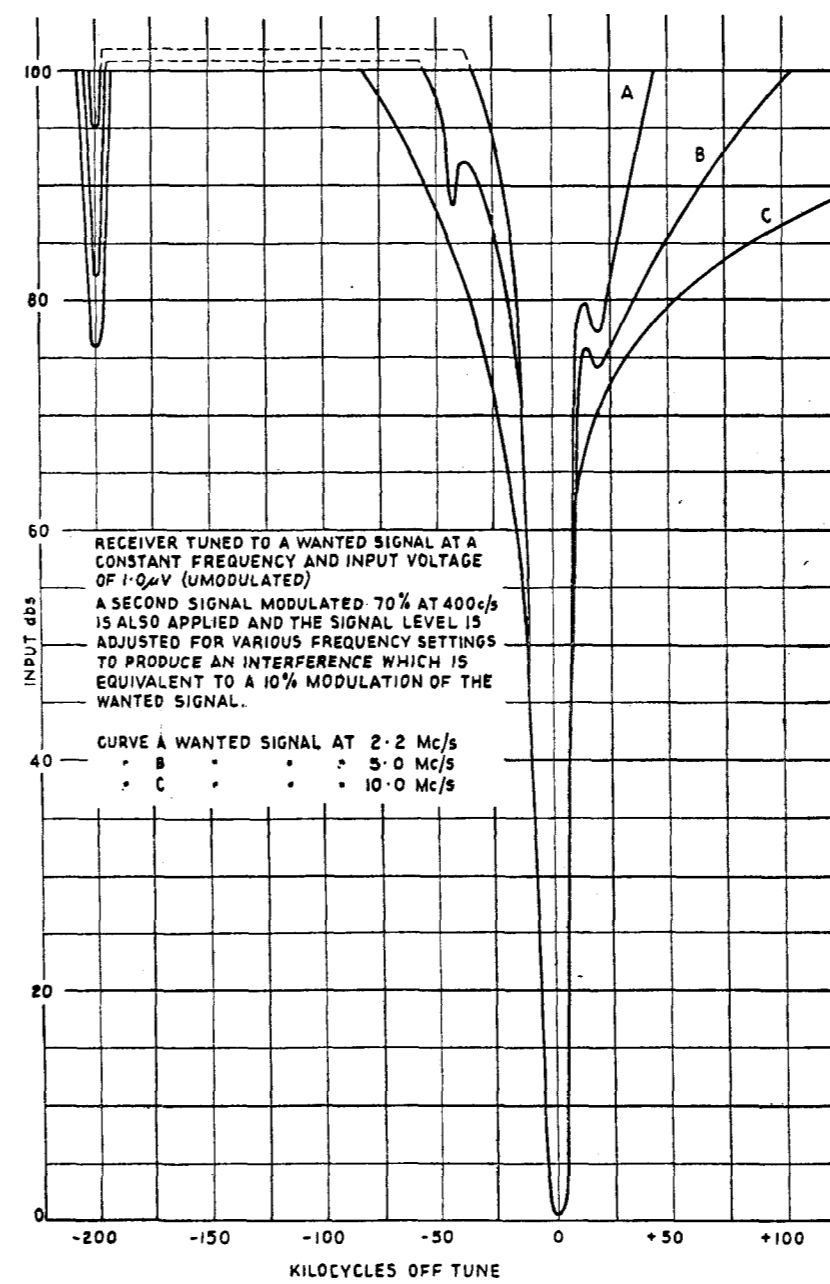

FIG. 13. SELECTIVITY CURVES.

5341

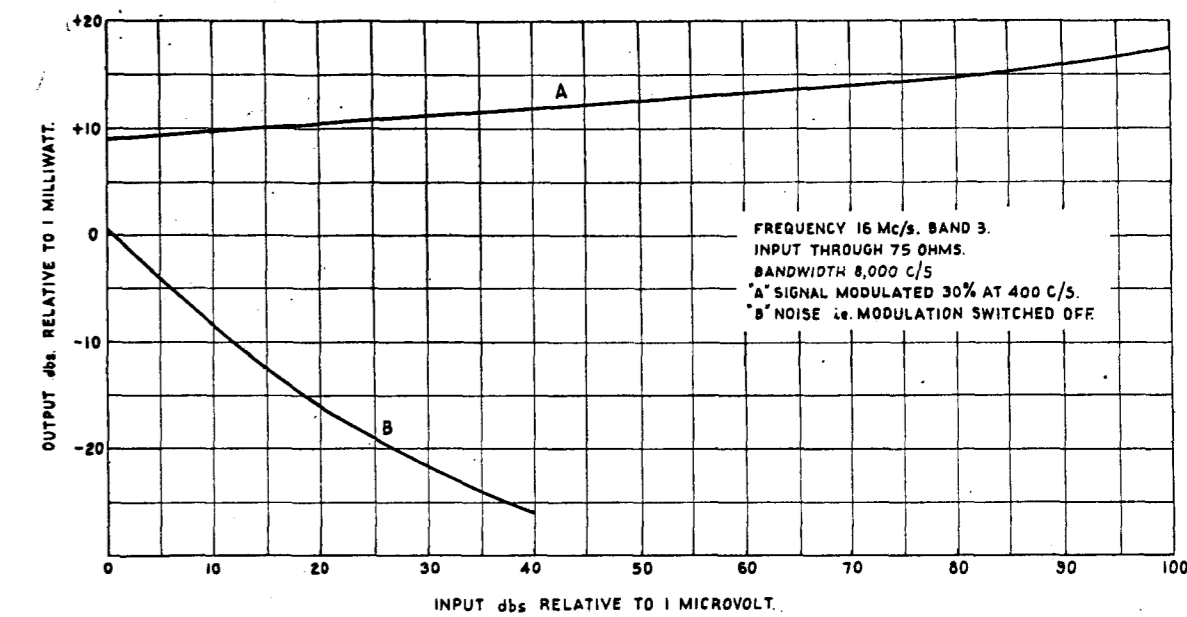

FIG. 15. AGC RESPONSE.

5343

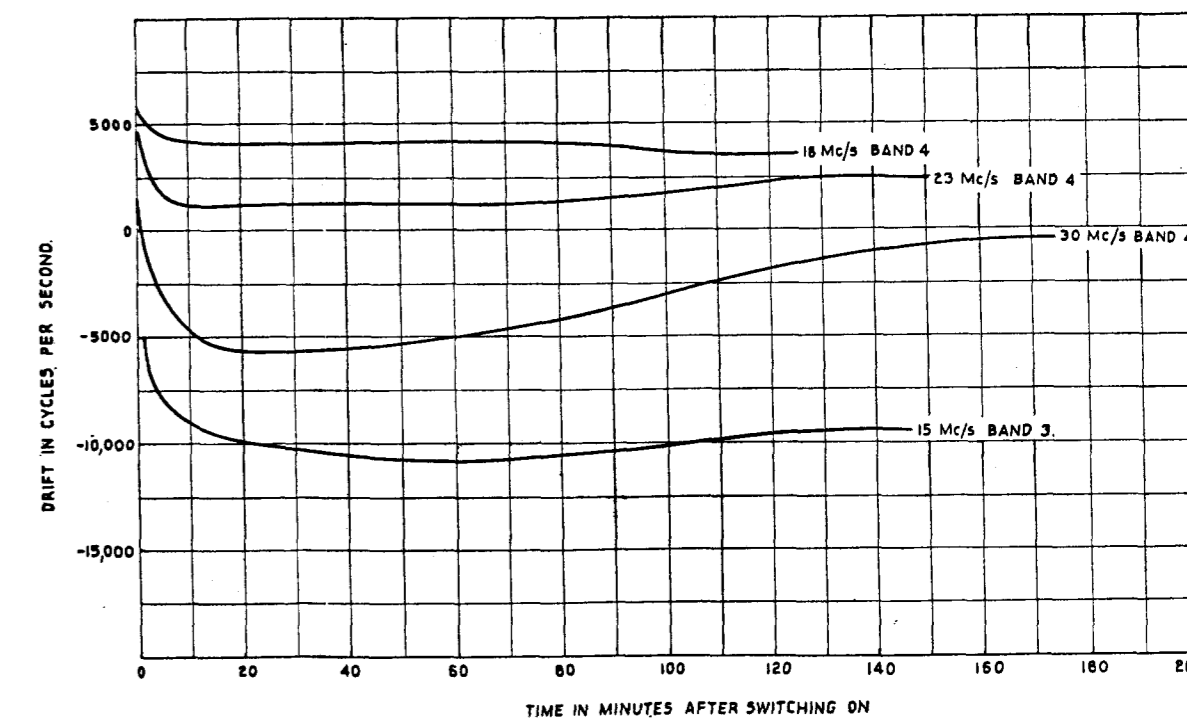
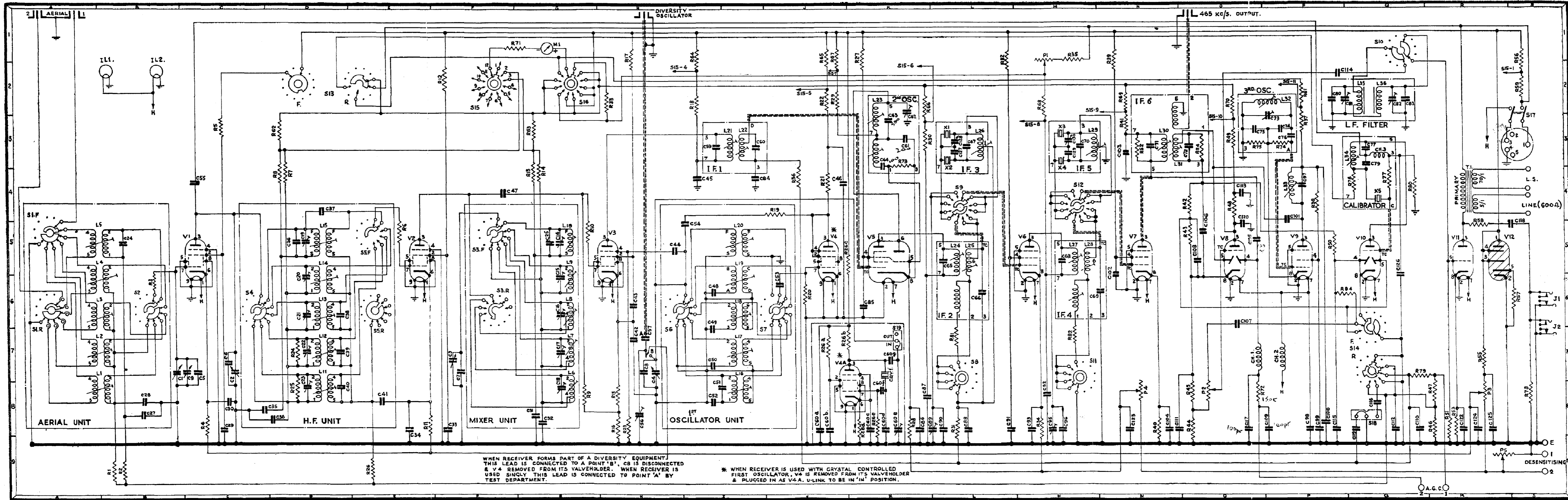

FIG. 16. FREQUENCY DRIFT.

5344

(Figs. 10-16)

47



WHEN RECEIVER FORMS PART OF A DIVERSITY EQUIPMENT THIS LEAD IS CONNECTED TO A POINT 'B', CB IS DISCONNECTED & V4 REMOVED FROM ITS VALVEHOLDER. WHEN RECEIVER IS USED SINGLY THIS LEAD IS CONNECTED TO POINT 'A' BY TEST DEPARTMENT.

* WHEN RECEIVER IS USED WITH CRYSTAL CONTROLLED FIRST OSCILLATOR, V4 IS REMOVED FROM ITS VALVEHOLDER & PLUGGED IN AS V4A. U-LINK TO BE IN 'IN' POSITION.

FIG. 17. CIRCUIT DIAGRAM OF RECEIVER